

ZOWN

the**classic**collection

2016



MAXCHIEF INVESTMENTS LTD.

MAXCHIEF INVESTMENTS LTD. is a holding company of Taiwanese origin with industrial plants in China, engaged primarily in the manufacture of office, garden and contract furniture. It set up "Dongguan Shichang Metals Factory Ltd." in August 1994 (65,000 m²) and the factory "Zhuhai Shichang Metals Ltd." in May 2010 (190,000 m²), where the holding company's main offices are currently found.

MAXCHIEF EUROPE S.L. was established in August 2008 as the holding company's sales and marketing subsidiary in Barcelona, one of the world's benchmark cities for industrial design, innovation and creativity.

MAXCHIEF INVESTMENTS LTD es un holding de origen taiwanés con plantas industriales en China, principalmente dedicadas a la fabricación de mobiliario de oficina, jardín y hostelería. En Agosto de 1994 creó la fábrica "Dongguan Shichang Metals Factory Ltd" (65.000 m²) y en mayo de 2010 la fábrica "Zhuhai Shichang Metals Ltd" (190.000 m²), dónde en la actualidad se encuentran las oficinas principales del holding.

MAXCHIEF EUROPE S.L. se constituyó en Agosto de 2008 como filial comercial y de marketing del Holding en Barcelona, una de las ciudades de referencia en el mundo en lo que respecta al diseño industrial, la innovación y la creatividad.

MAXCHIEF INVESTMENTS LTD est une holding d'origine taiwanaise avec des usines industrielles en Chine, se consacrant essentiellement à la fabrication de mobilier de bureau, de jardin et d'hôtellerie. En août 1994, la holding a fondé l'entreprise "Dongguan Shichang Metals Factory Ltd" (65.000 m²). En mai 2010 est créée l'entreprise "Zhuhai Shichang Metals Ltd" (190 000 m²), où se trouvent actuellement ses bureaux principaux.

MAXCHIEF EUROPE S.L. a été constituée en août 2008 comme filiale commerciale et marketing de la holding à Barcelone, une des villes de référence dans le monde en ce qui concerne le design industriel, l'innovation et la créativité.

MAXCHIEF INVESTMENTS LTD ist eine Holding aus Taiwan mit Fertigungswerken in China, in denen hauptsächlich Büro-, Garten- sowie Hotel- und Gastronomiemöbel hergestellt werden. Im August 1994 wurde das Werk „Dongguan Shichang Metals Factory Ltd“ (65.000 m²) und im Mai 2010 das Werk "Zhuhai Shichang Metals Ltd" (190.000m²) eröffnet, wo sich derzeit auch der Hauptsitz der Holding befindet.

MAXCHIEF EUROPE S.L. wurde im August 2008 als Vertriebs- und Marketingtochter der Holding mit Sitz in Barcelona gegründet, einer der weltweit führenden Städte in den Bereichen Industriedesign, Innovation und Kreativität.

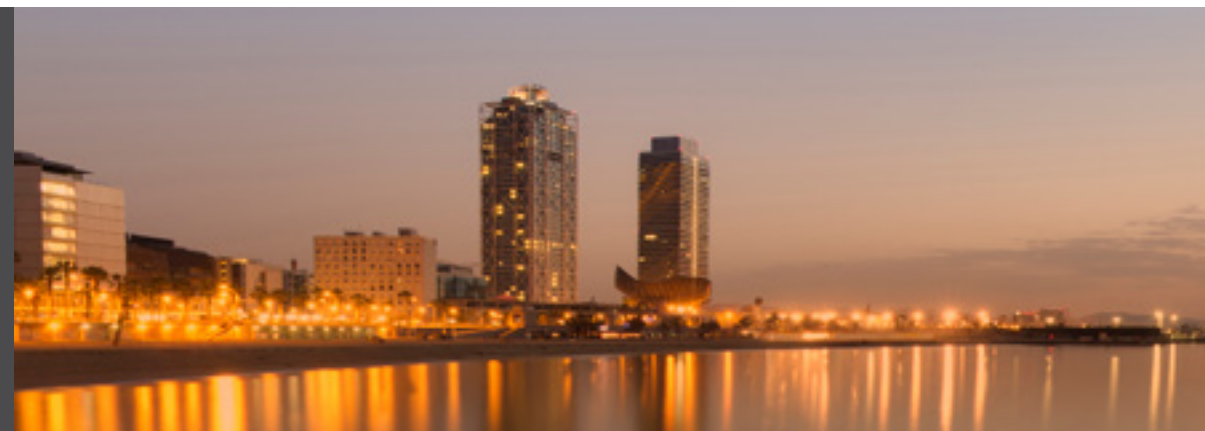

Zhuhai Shichang Metals Ltd.

Zhuhai, Guangdong, China

Dongguan Shichang Metals Factory Ltd.

Dongguan, Guangdong, China

- Engineering and Product Development
- Facilities equipped with cutting-edge technology
- Operations Management techniques seeking the highest quality and efficiency
- Ingeniería y Desarrollo de producto
- Instalaciones con tecnología de última generación
- Técnicas de Dirección de Operaciones orientada a la eficiencia y a la calidad total
- Ingénierie et Développement de produit
- Installations dotées d'une technologie de dernière génération
- Techniques de Direction des Opérations visant l'efficience et la qualité totale
- Produktentwicklung und Engineering
- Anlagen mit modernster Technologie
- Betriebsmanagement-Techniken zur Gewährleistung von Effizienz und umfassender Qualität

Maxchief Europe S.L.

Barcelona, Spain

- Market needs assessment
- Innovation, Creativity and Design
- European warranty
- Flexible and effective logistics
- Customer service
- Investigación de las necesidades del mercado
- Innovación, Creatividad y Diseño
- Garantía europea
- Logística flexible y eficaz
- Servicio al cliente
- Evaluation des besoins du marché
- Innovation, Créativité et Design
- Garantie européenne
- Logistique flexible et efficace
- Service au client
- Erforschung der Marktbedürfnisse
- Innovation, Kreativität und Design
- Gewährleistung europäischer Standards
- Flexible und effiziente Logistik
- Dienst am Kunden



ZOWN CONTRACT DESIGN FACTORY constitutes the holding company's brand targeting the **contract furniture** market, underpinned by a business philosophy which **integrates the entire value chain** (supply of raw materials, design, development, manufacture, distribution) and **combines the best of Asia and Europe** within one organisation.

From Asia, China brings its production potential and its modern infrastructure. Taiwan affords the management capacity of a management team boasting international training, expert in achieving high **productivity** and outstanding **quality** in factories equipped for large-scale production thanks to cutting-edge **technology**. In short, the keys to **competitiveness**.

From Europe, the team lends its expertise in **assessing the needs** of the global market, in **creativity** and in **design**. It manages **distribution** and provides a European **warranty** as well as effective and **flexible logistics**, basing its philosophy on the constant pursuit of innovation and commitment to customer **service**.

Since January 2015 Maxchief Europe S.L. has **internalised its logistics**, becoming established in a new industrial warehouse of 4,800 m² in Llinars del Vallès, Barcelona.

ZOWN CONTRACT DESIGN FACTORY es la marca del holding orientada al mercado del **mobiliario de uso profesional**, respaldada por una filosofía empresarial que **integra toda la cadena de valor** (aprovisionamiento de materias primas, diseño, desarrollo, fabricación, distribución) y **combina lo mejor de Asia y Europa** dentro de la misma organización.

Desde Asia, China aporta su potencial productivo y sus modernas infraestructuras. Taiwán, la capacidad de gestión de un equipo directivo con formación internacional, experimentados en obtener alta **productividad** en fábricas equipadas para la producción masiva con **sistemas de última generación**. En definitiva, las claves de la **calidad** y de la **competitividad**.

El equipo de Europa contribuye con la **investigación de las necesidades del mercado global**, la **creatividad** y el **diseño**. Gestiona la **distribución**, ofrece **garantía** europea así como una **logística flexible** y **eficaz**, basando siempre su trabajo en los pilares de la innovación y la obsesión por el **servicio al cliente**.

Desde Enero de 2015 Maxchief Europe S.L. **internaliza la función logística** estableciéndose en una nueva nave industrial de 4800 m² en Llinars del Vallès, Barcelona.



ZOWN CONTRACT DESIGN FACTORY est la marque du holding; ciblée sur le marché du **mobilier à usage professionnel**, elle repose sur une philosophie d'entreprise qui **intègre toute la chaîne de valeur** (approvisionnement en matières premières, conception, développement, fabrication, distribution) et qui **associe le meilleur de l'Asie et de l'Europe** au sein de la même organisation.

D'Asie, la Chine apporte son potentiel productif et ses infrastructures modernes ; Taiwan, la capacité de gestion d'une équipe de direction de formation internationale, experte pour obtenir une haute **productivité** et une haute **qualité** dans des usines équipées pour la production à grande échelle grâce à une **technologie** de dernière génération. En somme, les clés de la **compétitivité**.

D'Europe, l'équipe offre son expertise en matière d'**évaluation des besoins** du marché mondial, de créativité et de design. Elle gère la **distribution** et assure une **garantie** européenne, ainsi qu'une logistique flexible et efficace, sa philosophie étant fondée sur la recherche constante de l'**innovation** et sur son engagement envers le **service** à la clientèle.

Depuis janvier 2015, Maxchief Europe S.L. **internalise la fonction logistique** en établissant un nouveau bâtiment industriel de 4800 m² à Llinars del Vallès, province de Barcelone.

ZOWN CONTRACT DESIGN FACTORY ist die Marke der Holding für **Gewerbemöbel**, deren Unternehmensphilosophie die **gesamte Wertschöpfungskette** (Beschaffung der Rohstoffe, Design, Entwicklung, Herstellung, Vertrieb) **integriert** und **die Vorzüge Asiens und Europas** in einer Organisation **verbindet**.

In Asien steuert China sein Produktionspotential und seine modernen Infrastrukturen bei. Taiwan stellt die Führungsfähigkeiten eines Managementteams mit internationaler Ausbildung sowie Erfahrung in der Erzielung hoher **Produktivität** und **Produktqualität** in Großserienwerken mit modernster **Technologie** zur Verfügung, d.h. die Schlüssel der **Wettbewerbsfähigkeit**.

Das europäische Team trägt **Kreativität** und **Design** sowie seine Erfahrung in der Einschätzung der globalen **Marktbedürfnisse** bei. Darüber hinaus kümmert es sich um den Vertrieb und gewährleistet die Einhaltung europäischer Standards sowie eine effiziente und **flexible Logistik** auf der Grundlage einer Philosophie der ständigen **Innovation** und der Verpflichtung für den **Dienst am Kunden**.

Seit Januar 2015 hat Maxchief Europe S.L. **die Logistikkfunktion übernommen** und zu diesem Zweck eine neue, 4.800 m² große Industriehalle in Llinars del Vallès (Provinz Barcelona) bezogen.

FACTORY
FÁBRICA
USINE
WERK

Each and every member of the company team strives to constantly improve the level of quality and efficiency. In recognition of this commitment, the company was awarded the certifications for a quality management system (ISO 9001: 2008), environmental management system (ISO 14001: 2004) and occupational health and safety management system (OHSAS 18001: 2007).

Todo el equipo de la empresa trabaja orientado hacia la mejora continua de la calidad y la eficiencia. En reconocimiento a este compromiso, la compañía ha recibido certificaciones de gestión de la calidad (ISO 9001.2008), del impacto medioambiental (ISO 14001.2004), así como de la gestión de la salud y la seguridad en el trabajo (OHSAS18001.2007).

Toute l'équipe de l'entreprise travaille dans l'optique de l'amélioration continue de la qualité et de l'efficience. En reconnaissance à cet engagement, la compagnie a reçu les certifications de gestion de la qualité (ISO 9001.2008), de l'impact environnemental (ISO 14001.2004), ainsi que celle de la gestion de la santé et de la sécurité au travail (OHSAS18001.2007).

Der gesamte Mitarbeiterstab des Unternehmens ist auf die ständige Verbesserung der Qualität und Effizienz ausgerichtet. In Anerkennung dieses Engagements hat das Unternehmen Zertifizierungen in den Bereichen Qualitätsmanagement (ISO 9001.2008), Umweltmanagement (ISO 14001.2004) sowie Sicherheit und Gesundheit am Arbeitsplatz (OHSAS18001.2007) erhalten.



The factory is equipped with 41 HDPE blow moulding machines, 12 polypropylene injection machines and several steel pipe production lines. The factory is also fitted out with 45 digital welding robots and 4 powder coating lines. All of the above yields a production of between 600 and 800 containers per month.

Las plantas productivas cuentan con 41 máquinas de tecnología HDPE blow moulding, 12 inyectoras de Polipropileno y varias líneas de fabricación de tubo de acero. Disponen también de 45 robots de soldadura digital y 4 cadenas de pintado poder coating. Todo ello permite alcanzar producciones de 600 a 800 containers al mes.

Les ateliers de production disposent de 41 machines de technologie HDPE blow moulding, de 12 machines à injection de polypropylène et de plusieurs chaînes de fabrication de tubes en acier. Ils disposent également de 45 robots de soudage numérique et de 4 chaînes de peinture poder coating. Tout cela permet d'atteindre un rythme de production de 600 à 800 containers par mois.

Die Fertigungswerke verfügen über 41 HDPE-Blasformanlagen, 12 Polypropylen-Spritzgussanlagen und mehrere Produktionsstraßen für Stahlrohre. Dazu kommen 45 digitale Schweißroboter und 4 Pulverlackieranlagen. Dank dieser Einrichtungen können monatlich zwischen 600 und 800 Container mit unseren Produkten beladen werden.

ZOWN

WHY?
¿POR QUÉ?
POURQUOI?
WARUM?

Because the professional needs furniture:

Light and shock-proof. Stable and capable of withstanding weight. Durable, competitive and low-maintenance.

Comfortable for users. With a broad range of compatible models of various sizes. Assembled and disassembled rapidly, safely and repeatedly. Easily transported and stored, saving space.

Manufactured from easy-to-clean hygienic materials. Damp-proof and UV-proof. Suitable for indoor and outdoor use.

Porque el profesional necesita mobiliario:

Ligero y resistente a los impactos. Estable y adecuado para soportar peso. Duradero, competitivo y de bajo mantenimiento.

Cómodo para los usuarios. Con amplia variedad de modelos compatibles, de diferentes dimensiones.

Rápido y seguro para ser montado y desmontado con frecuencia. Fácil de transportar y de ser almacenado economizando espacio.

Fabricado con materiales higiénicos y fáciles de limpiar. Resistente a la humedad y a los rayos UV. Apropriado para uso interior y exterior.

Parce que les professionnels ont besoin de mobilier:

Léger et résistant en cas de choc. Stable et apte à supporter des charges lourdes. Durable, compétitif et nécessitant peu d'entretien.

Pratique pour les utilisateurs. Possédant une grande variété de modèles compatibles, de différentes dimensions.

Rapide et sûr pour être monté et démonté fréquemment. Facile à transporter et à stocker en économisant de l'espace.

Fabriqué à base de matériaux hygiéniques et faciles à nettoyer. Résistant à l'humidité et aux rayons UV. Apte pour usage intérieur et extérieur.

Weil Profis hohe Anforderungen an Möbel stellen:

Sie sollen leicht und schlagfest sein. Stabil und von hoher Tragkraft. Langlebig, preisgünstig und pflegeleicht.

Bequem für die Benutzer. Verfügbar in einer breiten Produktpalette und in unterschiedlichen Größen.

Schnell und sicher auf- und abzubauen. Leicht zu transportieren und platzsparend aufzubewahren.

Aus hygienischen Werkstoffen gefertigt und leicht zu reinigen. Feuchtigkeits- und UV-beständig. Geeignet sowohl für den Innen- als auch für den Außenbereich.



TABLE OF CONTENTS

tabla de contenidos / sommaire / inhaltsverzeichnis

INTRODUCTION

- Pg12 the**classic**colletion presentation
- Pg18 the**textile**colletion presentation
- Pg26 key / **leyenda** / légende / **legende**

M SYSTEM

- 45 cm / 18"
- Pg28 **M183**
- Pg29 **oxford180**

L SYSTEM

- 60 cm / 24"
- Pg30 **L120**
- Pg31 **Ltrolley**

XL SYSTEM

- 75 cm / 30"
- Pg34 **XL150**
- Pg36 **XL180**
- Pg38 **worktop180**
- Pg41 **topshelf180**
- Pg42 **XL240**
- Pg44 **XLtrolley**
- Pg46 **XLmoon**
- Pg48 **XLcorner**

XXL SYSTEM

- 90 cm / 36"
- Pg50 **XXL90**
- Pg52 **XXL200**
- Pg54 **XXL240**
- Pg56 **XXLcorner**
- Pg57 **XXLtrolley**
- Pg58 **XXLmoon**

PLANET SYSTEM

- ●
- Pg62 **planet120**
- Pg64 **planet150**
- Pg66 **planet160**
- Pg68 **planet180**
- Pg70 **planettrolley**

OTHER ITEMS

- Pg40 **buffettablebase**
- Pg72 **snacktable**
- Pg74 **cocktail80**
- Pg80 **praxis80**
- Pg82 **cocktailtrolley**
- Pg83 **x-uptable**
- Pg84 **oktober175**
- Pg85 **sharpbench240**
- Pg86 **sharpbench180**
- Pg87 **sharptable**
- Pg88 **munich70**
- Pg89 **munichbench**
- Pg90 **SS60**
- Pg91 **SS120**
- Pg109 **displayrack**

CHAIRS

- Pg78 **markusstool**
- Pg92 **alexchair**
- Pg93 **alex-kchair**
- Pg96 **alexandrachair**
- Pg97 **alexandra-kchair**
- Pg98 **alexrolley**
- Pg99 **alexandratrolley**
- Pg100 **ottochair**
- Pg101 **ottotrolley**
- Pg102 **normanchair**
- Pg103 **normantrolley**
- Pg106 **boston-kchair**
- Pg107 **liamtrolley**
- Pg108 **igorchair**

SUMMARY

- Pg111 **summary**

ZOWN

the **classic** collection

THE TESTER video!



We have performed a shock and load test comparing Zown folding tables with asian competitor's tables. **Watch the tester results!**

Hemos realizado pruebas de resistencia a impactos y de capacidad de carga comparando las mesas plegables de Zown con las mesas de los competidores asiáticos. **¡Mira los resultados de las pruebas!**

Nous avons effectué des essais de résistance aux chocs et aux charges en comparant les tables pliables de Zown à des tables fabriquées par des concurrents asiatiques. **Regardez les résultats!**

Wir haben die Klappische von Zown in einem Stoß- und Lasttest mit Tischen asiatischer Mitbewerber verglichen. **Werfen Sie einen Blick auf die Testergebnisse!**

The ZOWN CLASSIC Collection features lightweight folding furniture for professional use at banquets and events, and in the hotel and catering industry. **Proven reliability.** Lightweight, shockproof, robust furniture with a weight-bearing capacity. Hard-wearing, **competitive** and low maintenance. **The widest variety of compatible models** of different sizes. Easy to assemble and disassemble, to transport and to store (saving on space). Hygienic and easy to clean. Resistant to moisture and UV rays. Suitable for indoor and outdoor use.

Colección ZOWN CLASSIC de mobiliario ligero plegable para uso profesional en banquetes, eventos, catering y hoteles. **Solvencia contrastada.** Mobiliario ligero y resistente a los impactos, estable y adecuado para soportar peso. Duradero, **competitivo** y de bajo mantenimiento. **La más amplia variedad de modelos** compatibles de diferentes dimensiones, Fácil de montar, desmontar, transportar y ser almacenado economizando espacio. Higiénico y fácil de limpiar. Resistente a la humedad y rayos UV. Apto para uso interior y exterior.

Collection ZOWN CLASSIC de mobilier léger et pliable pour usage professionnel lors de banquets, événements, buffets et en hôtel. **Fiabilité vérifiée.** Mobilier léger et résistant aux impacts, stable et capable de supporter un poids. Durable, **compétitif** et nécessitant peu d'entretien. **Large choix de modèles compatibles** de différentes dimensions. Facile à monter, à démonter, à transporter et à stocker avec gain de place. Hygiénique et facile à nettoyer. Résistant à l'humidité et aux rayons UV. Apte pour un usage intérieur et extérieur.

Die Kollektion ZOWN CLASSIC besteht aus leichten Klappmöbeln für den gewerblichen Einsatz bei Festessen, Veranstaltungen sowie im Catering- und Hotel-Bereich. **Im Einsatz bewährt.** Leichtes, schlagfestes, stabiles und belastbares Mobiliar. Langlebig, **preisgünstig** und pflegeleicht. Verfügbar in einer **breiten Produktpalette** und in unterschiedlichen Größen. Leicht auf- und abzubauen und zu transportieren. Platzsparend in der Lagerung. Hygienisch und leicht zu reinigen. Feuchtigkeits- und UV-beständig. Sowohl für den Innen- als auch für den Außenbereich geeignet.

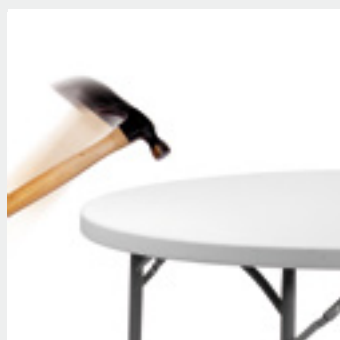

Pure polyethylene, unmixed. Quality raw material with UV protection. Shock-proof. Constructed to withstand heavy loads. Suitable for outdoor use.

Poliétileno puro, sin mezclas. Materia prima de calidad y con protección UV. Flexible ante los impactos. Resistente bajo cargas pesadas. Apto para uso exterior.

Polyéthylène pur, sans mélange. Matière première de qualité, protection contre les UV. Flexibilité en cas de chocs. Résistance aux charges lourdes. Apte pour usage extérieur.

Reines Polyethylen, ohne Beimischungen. Hochwertiges Ausgangsmaterial mit UV-Schutz. Schlagzäh und von hoher Tragfähigkeit. Für den Einsatz im Außenbereich geeignet.

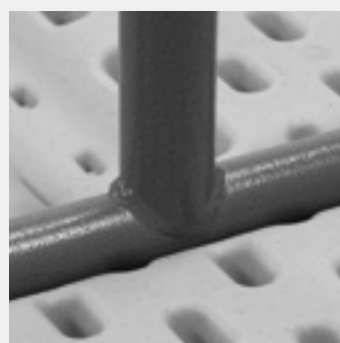

Continuous digitally welded joints. Precise and indestructible. Powder coated steel. Shock-proof and damp-proof.

Soldaduras digitales en línea. Precisas e indestructibles. Acero pintado por pulverización, resistente a los impactos y a la humedad.

Soudage numérique en ligne. Précis et indestructible. Acier peint par pulvérisation, résistant aux chocs et à l'humidité.

Digital ausgeführte Schweißnähte, präzise und unzerstörbar. Pulverlackierter Stahl, schlagfest und feuchtigkeitsbeständig.



Metal profiles of a thickness designed to withstand extreme loads.

Perfiles metálicos con grosor dimensionado para soportar cargas extremas.

Profils métalliques d'une épaisseur apte à supporter des charges extrêmes.

Metallprofile von ausreichender Dicke für extreme Belastungen.

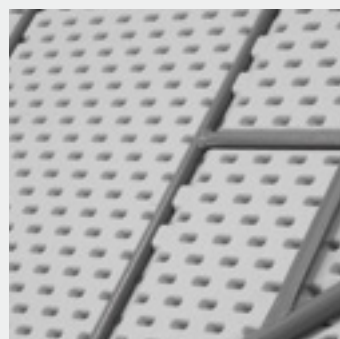

High density of vaults in the lower surface of the table top. Resistant and non-warping.

Alta densidad de bóvedas en el plano inferior del sobre. Resistente e indeformable.

Haute densité des voûtes sur le plan intérieur du plateau. Résistant et indéformable.

Zahlreiche wabenförmige Öffnungen an der Unterseite der Tischplatte. Strapazierfähig und unverformbar.

Individual polypropylene clip to hold the leg in position when folded. Solid and durable fastening device.

Clip independiente de polipropileno para albergar la pata en posición de plegado. Fijación perfecta y duradera.

Clip indépendant de polypropylène pour maintenir le pied en position pliée. Fixation parfaite et durable.

Unabhängige Klammer aus Polypropylen zur Aufnahme des Tischbeins in Klappposition. Perfekte und dauerhafte Fixierung.

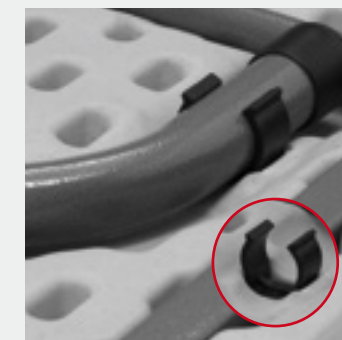

Solid welded joints, nuts and bolts.

Tornillería y soldaduras sólidas.

Visserie et soudures solides.

Solide Schraub- und Schweißverbindungen.



Metal structures designed to optimise the weight/resistance ratio. The recommended maximum weight that appears on each page of the product refers to "evenly distributed" weight on the surface of the product. For the recommended maximum "concentrated" weight, please contact our sales department.

Estructuras metálicas diseñadas para optimizar la relación peso/resistencia. El peso máximo recomendado que figura en cada página de producto se refiere al peso "uniformemente repartido" en la superficie del artículo. Para conocer el peso "concentrado" máximo recomendado, consultar a nuestro departamento comercial.

Structures métalliques conçues pour un rapport poids/résistance optimal. Le poids maximum recommandé qui figure sur chaque page de produit se réfère au poids «réparti uniformément» sur la surface de l'article. Pour connaître le poids «concentré» maximum recommandé, consulter notre département commercial.

Speziell konstruierte Metallgestelle zur Optimierung des Verhältnisses zwischen Gewicht und Festigkeit. Das auf den einzelnen Produktseiten angegebene Maximalgewicht bezieht sich auf ein gleichmäßig auf der Oberfläche des Artikels verteiltes Gewicht. Auskünfte über das empfohlene maximale Punktgewicht erhalten Sie von unserer Verkaufsabteilung.



COMPOSITIONS COMPOSICIONES COMPOSITIONS ZUSAMMENSTELLUNGEN

The XL system is a set of tables 30" nominal wide (see exact measurements on each product page) which can be joined and combined to make multiple and diverse configurations. The XL system is specially designed for events in which optimising the available space constitutes a priority.

The XXL system offers the same versatility but with tables 36" wide. The spacious XXL system makes for more elaborate arrangements as well as affording maximum comfort to table guests.

The flexibility of the XL and XXL facilitates their adaptation to the unique attributes of every event.

El sistema XL es un conjunto de mesas con un ancho de 76 cm nominales (ver medidas exactas en cada página de producto) que se pueden unir y combinar para formar múltiples y variadas configuraciones. El sistema XL está especialmente indicado para aquellos eventos donde optimizar el espacio disponible es un factor clave.

El sistema XXL ofrece la misma versatilidad pero con mesas con un ancho de 90 cm nominales (ver medidas exactas en cada página de producto). El espacioso sistema XXL permite decoraciones de mayor vistosidad, además de otorgar excelente confort a los comensales.

La flexibilidad de los sistemas XL y XXL permite adaptarse a las singularidades de cada evento.

Le système XL est un ensemble de tables d'une largeur nominale de 76 cm (voir dimensions exactes sur chaque page de produit) que l'on peut assembler et combiner selon des configurations multiples et variées. Le système XL est particulièrement indiqué pour les événements où l'optimisation de l'espace disponible est un facteur clé.

Le système XXL offre la même polyvalence mais avec des tables de 90 cm de largeur nominale (voir dimensions exactes sur chaque page de produit). Le système XXL, particulièrement spacieux, permet non seulement un type de décoration plus élégante mais assure également un confort d'excellente qualité pour les convives.

La flexibilité des systèmes XL et XXL permet de s'adapter aux singularités de chaque événement.

Das System XL besteht aus Tischen mit einer Breite von 76 cm (genaue Abmessungen siehe jeweilige Produktseite), die auf verschiedenste Weise und in unterschiedlichsten Konfigurationen kombiniert werden können. Das System XL ist besonders für jene Anlässe geeignet, in denen es auf die optimale Nutzung des verfügbaren Raumes ankommt.

Das System XXL bietet die gleiche Vielseitigkeit jedoch mit einer Tischbreite von 90 cm (genaue Abmessungen siehe jeweilige Produktseite). Das großzügige System XXL erlaubt eine aufwändigere Dekoration und bietet den Gästen einen besonderen Komfort.

Die Flexibilität der Systeme XL und XXL ermöglicht es, die Besonderheiten der jeweiligen Veranstaltung zu berücksichtigen.



Transverse / longitudinal table joining system
Sistema de unión transversal / longitudinal
Système d'assemblage transversal / longitudinal
Quer Verbindungssystem / Längs Verbindungssystem

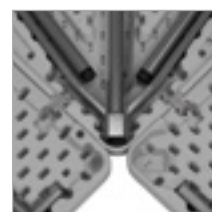

Angular table joining system
Sistema de unión angular
Système d'assemblage angulaire
Eckverbindungssystem

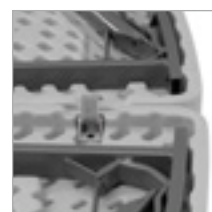

Circular table joining system
Sistema de unión circular
Système d'assemblage circulaire
Kreisförmiges Verbindungssystem

XL SYSTEM

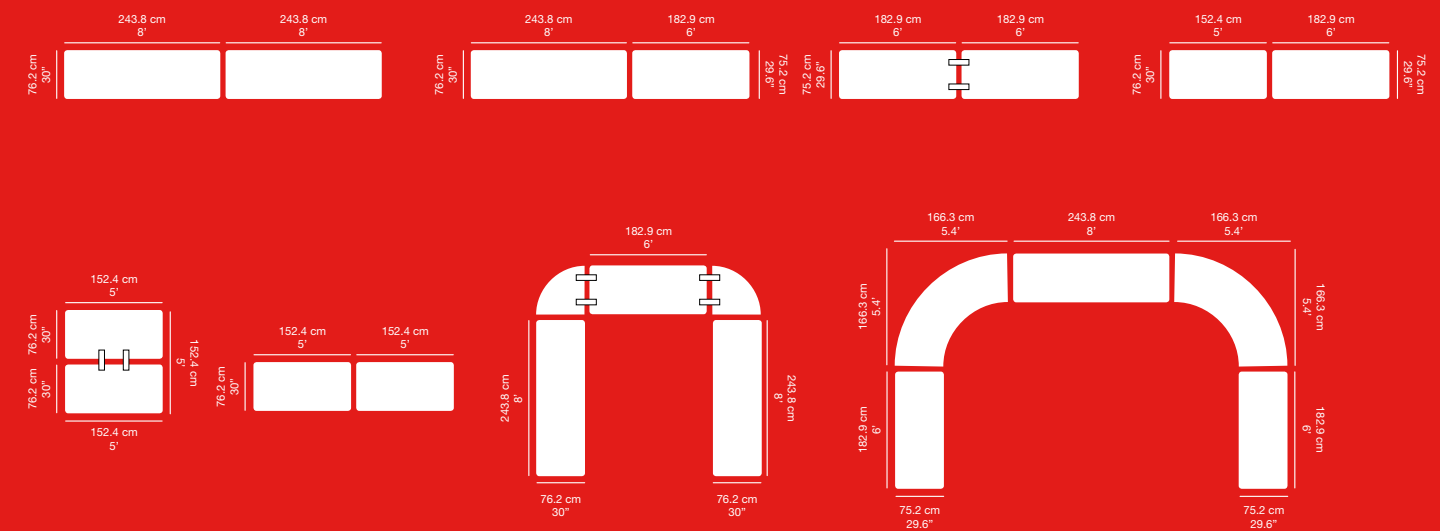

XL SYSTEM + planet180

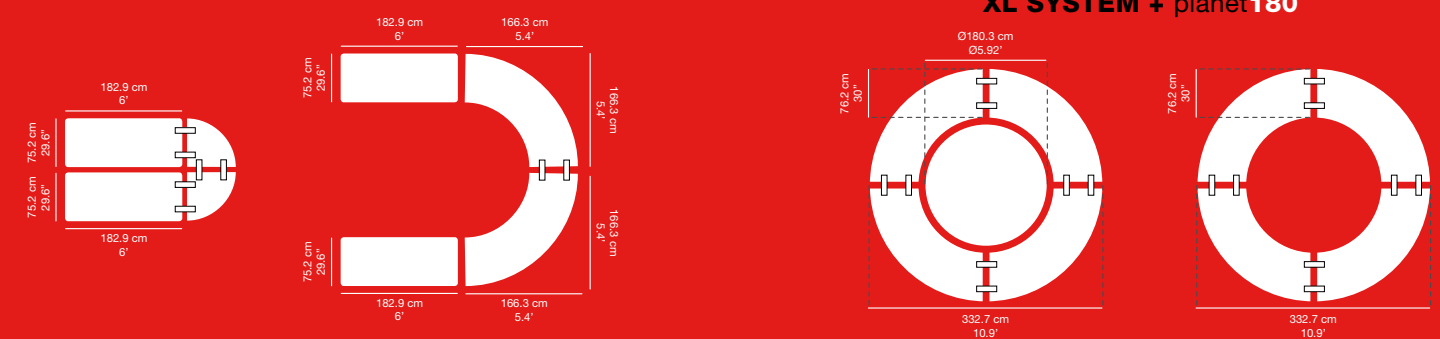

XXL SYSTEM

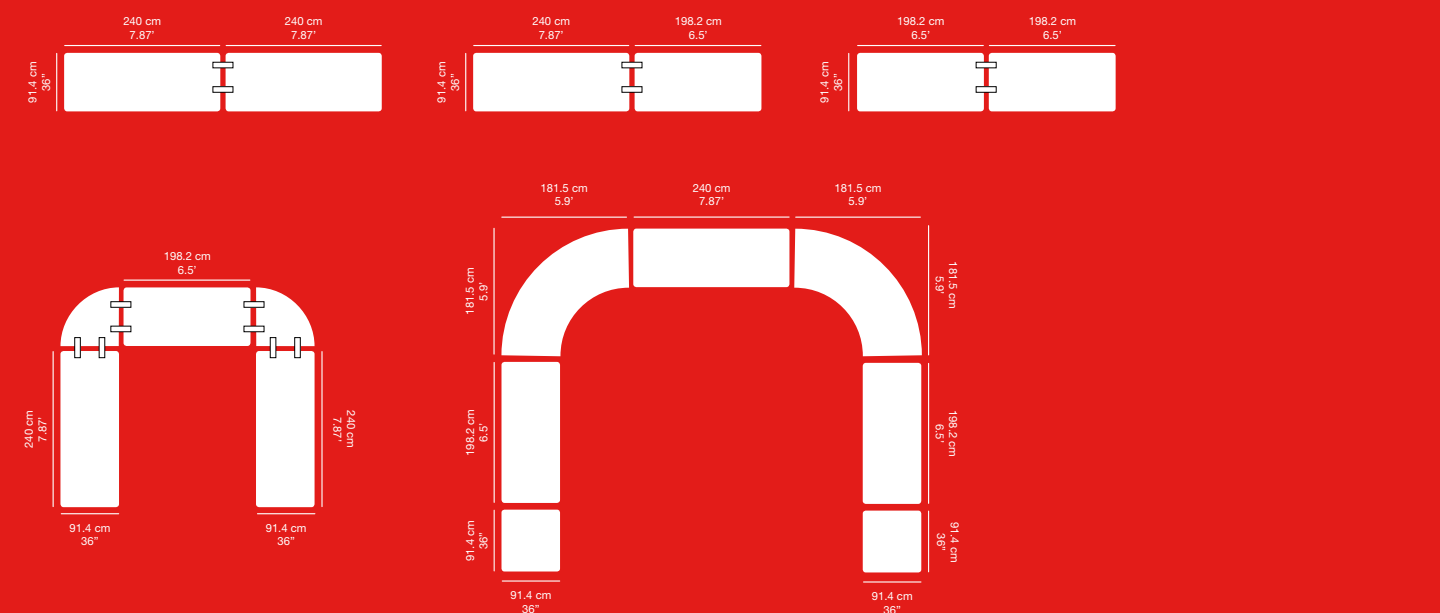

XXL SYSTEM + planet180

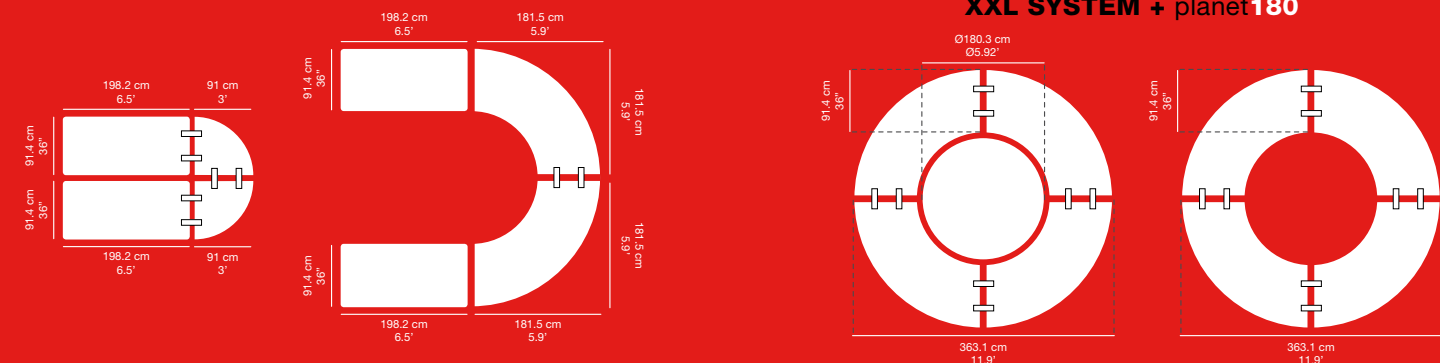

thetextilecollection









The Zown Textile Collection comprises a range of standard furniture covers especially designed to fit each of Zown's classic products. A broad spectrum of styles and solid colours are available. This Textile Collection is set apart by:

- Styles fully in line with Zown's classic product range of furniture.
- Fabrics and weights which have been selected to strike the perfect balance between performance, aesthetics and durability.
- Special stitching designed to create strong seams and fray-resistant edges in order to withstand wear and tear.
- Crease-resistant fabrics, which are easy to wash and iron, retaining their shape and with no shrinkage.
- Stretch fabric containing 10% Lycra, which is elastic and returns to its original shape without any deformation.

La colección textil de Zown comprende toda una gama de fundas para muebles estándar especialmente diseñada para que se adapte a todos y cada uno de los productos de la colección Zown Classic. Disponibles en un amplio abanico de estilos y colores sólidos, los artículos de esta colección se distinguen por:

- Patrones perfectamente ajustados a la colección de muebles Zown classic.
- Las telas y sus gramajes han sido seleccionados para lograr el equilibrio perfecto entre rendimiento, estética y durabilidad.
- Costuras especialmente confeccionadas para crear uniones fuertes que soporten bien los tirones y bordes resistentes que no se deshilachen.
- Tejidos resistentes a las arrugas y fáciles de lavar y planchar. Mantienen su forma sin encogerse.
- Tejidos stretch con un 10% de lycra, les dota de elasticidad y les permite recuperar su forma original sin deformarse.



 White - Bianco Blanc - Weiß	 White - Bianco Blanc - Weiß
 Black - Negro Noir - Schwarz	 Black - Negro Noir - Schwarz
 Red - Rojo Rouge - Rot	 Anthracite - Antracita Anthracite - Anthrazit
 Green - Verde Vert - Grün	 Blue - Azul Bleu - Blau
 Orange - Naranja Orange - Orange	 Burgundy - Burdeos Bordeaux - Bordeaux
 Turquoise - Turquesa Turquoise - Türkis	
 Pink - Rosa Rose - Rosa	

La Collection Textile Zown est constituée d'une gamme de housses de meubles standard, spécialement conçues pour s'adapter à chaque produit Zown classic. Un large choix de styles et de couleurs unies est disponible. Cette Collection Textile se distingue grâce aux éléments suivants:

- Styles en accord parfait avec la gamme de meubles Zown classic.
- Tissus et poids pensés pour obtenir l'équilibre parfait entre performance, esthétique et durabilité.
- Mode de fabrication spécialement mis au point pour obtenir des coutures durantes et des bords qui ne s'effilochent pas, afin de résister à l'usure naturelle.
- Tissus anti-plis, faciles à laver et à repasser, qui conservent leur forme et ne rétrécissent pas.
- Tissu stretch contenant 10% de lycra : élastique, il reprend sa forme d'origine sans aucune déformation.

Die Textil-Kollektion von Zown beinhaltet verschiedene Standard-Hussen, die speziell den einzelnen Zown-Classic-Produkten angepasst sind. Zur Auswahl steht eine breite Palette an Modellen und beständigen Farben. Die Textil-Kollektion besticht durch folgende Merkmale:

- Die Modelle sind vollständig auf die Zown-Classic-Möbel abgestimmt.
- Die Stoffe und Stärken zielen auf ein perfektes Gleichgewicht aus Leistung, Ästhetik und Strapazierfähigkeit.
- Verschleißbeständige Spezialnähte für dauerhaft feste Säume und fransenlose Ränder.
- Pflegeleichte, faltenbeständige Stoffe, die ihre Form beim Waschen und Bügeln behalten und nicht eingehen.
- Elastischer Stretch-Stoff mit 10% Lycra, nimmt ohne Verziehen wieder seine Ausgangsform ein.

SPECIAL FEATURES

características especiales / caractéristiques spéciales / besondere merkmale



Indelible label sewn to the product which clearly indicates its name and use for rapid identification and classification, thereby avoiding confusion and time-wasting.

Etiquetas indelebles cosidas al producto que indican claramente su nombre y utilidad para una rápida identificación y clasificación, evitando desórdenes y pérdidas de tiempo.

Étiquettes indélébiles cousues aux produits indiquant clairement leur nom et leur utilité pour une identification et un tri rapides, évitant ainsi désordres et pertes de temps.

Am Produkt festgenähte, unlöschbare Etiketten mit klarer Angabe des Namens und Verwendungszwecks für eine rasche Identifikation und Sortierung, um Verwirrung und unnötigen Zeitaufwand zu vermeiden.

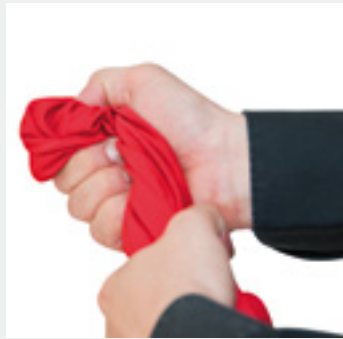

Crease-resistant fabrics, which are easy to wash and iron, retaining their shape and with no shrinkage.

Tejidos resistentes a las arrugas y fáciles de lavar y planchar. Mantienen su forma sin encogerse.

Tissus anti-plis, faciles à laver et à repasser, qui conservent leur forme et ne rétrécissent pas.

Pflegeleichte, faltenbeständige Stoffe, die ihre Form beim Waschen und Bügeln behalten und nicht eingehen.

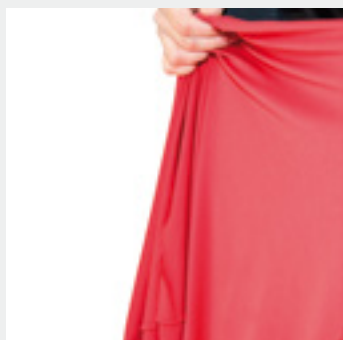

Special stitching designed to create strong seams and fray-resistant edges in order to withstand wear and tear.

Costuras especialmente confeccionadas para crear uniones fuertes que soporten bien los tirones y bordes resistentes que no se deshilachen.

Mode de fabrication spécialement mis au point pour obtenir des coutures durantes et des bords qui ne s'effilochent pas, afin de résister à l'usure naturelle.

Verschleißbeständige Spezialnähte für dauerhaft feste Säume und fransenlose Ränder.

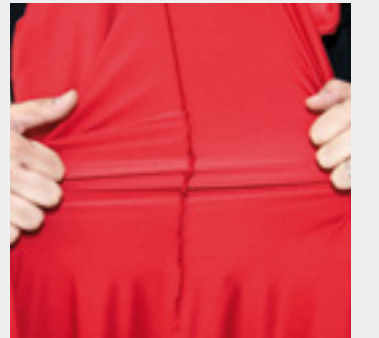
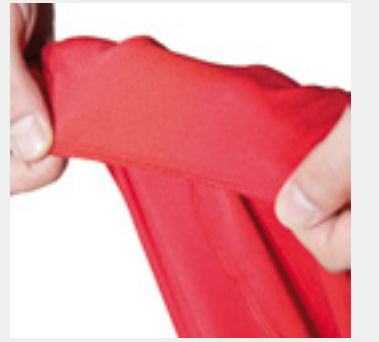

Attractive packaging which clearly identifies its content and use, facilitating its classification, display and storage.

Embalajes atractivos que identifican claramente su contenido y utilidad, facilitando su clasificación, exposición y conservación.

Emballages attrayants qui permettent d'identifier clairement leur contenu et l'utilité des produits, facilitant ainsi leur tri, leur exposition et leur entreposage.

Attraktive Verpackungen mit klarer Angabe von Inhalt und Verwendungszweck zur einfacheren Sortierung, Ausstellung und Aufbewahrung.



STYLES

estilos / styles / stile

Full Table, Bench and Top Cover Shapes

stretch

90% PES 10% LYCRA,
200 g/m², knitted



- White - Blanco
Blanc - Weiß
- Black - Negro
Noir - Schwarz
- Red - Rojo
Rouge - Rot
- Green - Verde
Vert - Grün
- Orange - Naranja
Orange - Orange
- Turquoise - Turquesa
Turquoise - Türkis
- Pink - Rosa
Rose - Rosa

paramount

100% PES,
200 g/m², knitted



- White - Blanco
Blanc - Weiß
- Black - Negro
Noir - Schwarz
- Anthracite - Antracita
Anthracite - Anthrazit
- Blue - Azul
Bleu - Blau
- Burgundy - Burdeos
Bordeaux - Bordeaux

plain

100% PES,
200 g/m², knitted



- White - Blanco
Blanc - Weiß
- Black - Negro
Noir - Schwarz
- Anthracite - Antracita
Anthracite - Anthrazit
- Blue - Azul
Bleu - Blau
- Burgundy - Burdeos
Bordeaux - Bordeaux

bridge

100% PES,
200 g/m², knitted



- White - Blanco
Blanc - Weiß
- Black - Negro
Noir - Schwarz
- Anthracite - Antracita
Anthracite - Anthrazit
- Blue - Azul
Bleu - Blau
- Burgundy - Burdeos
Bordeaux - Bordeaux

Partial Table Skirt

paramount

100% PES,
200 g/m², knitted



- White - Blanco
Blanc - Weiß
- Black - Negro
Noir - Schwarz
- Anthracite - Antracita
Anthracite - Anthrazit
- Blue - Azul
Bleu - Blau
- Burgundy - Burdeos
Bordeaux - Bordeaux

Chair Cover Shapes

stretch

90% PES 10% LYCRA,
200 g/m², knitted



- White - Blanco
Blanc - Weiß
- Black - Negro
Noir - Schwarz
- Red - Rojo
Rouge - Rot
- Green - Verde
Vert - Grün
- Orange - Naranja
Orange - Orange
- Turquoise - Turquesa
Turquoise - Türkis
- Pink - Rosa
Rose - Rosa

classic

100% PES,
200 g/m², knitted



- White - Blanco
Blanc - Weiß
- Black - Negro
Noir - Schwarz
- Anthracite - Antracita
Anthracite - Anthrazit
- Blue - Azul
Bleu - Blau
- Burgundy - Burdeos
Bordeaux - Bordeaux

Chair Sash Shapes

plain

90% PES 10% LYCRA,
200 g/m², knitted



twist

90% PES 10% LYCRA,
200 g/m², knitted



classic

90% PES 10% LYCRA,
200 g/m², knitted



- White - Blanco
Blanc - Weiß
- Black - Negro
Noir - Schwarz
- Red - Rojo
Rouge - Rot
- Green - Verde
Vert - Grün
- Orange - Naranja
Orange - Orange
- Turquoise - Turquesa
Turquoise - Türkis
- Pink - Rosa
Rose - Rosa

Tablecloths

tablecloths

100% CO,
230 g/m²



- White - Blanco
Blanc - Weiß

Top Cover

stretch

90% PES
10% LYCRA,
200 g/m²,
knitted



- White - Blanco
Blanc - Weiß
- Black - Negro
Noir - Schwarz
- Red - Rojo
Rouge - Rot
- Green - Verde
Vert - Grün
- Orange - Naranja
Orange - Orange
- Turquoise - Turquesa
Turquoise - Türkis
- Pink - Rosa
Rose - Rosa

COLOURS

colores / couleurs / farben

stretch Table, Bench and Chair Cover Colours 90% PES 10% LYCRA, 200 g/m², knitted



paramount Cover and Partial-Skirt Colours 100% PES, 200 g/m², knitted



plain Cover Colours 100% PES, 200 g/m², knitted



bridge Cover Colours 100% PES, 200 g/m², knitted



stretch Chair Cover Colours 90% PES 10% LYCRA, 200 g/m², knitted



classic Chair Cover Colours 100% PES, 200 g/m², knitted



Chair sash Colours 90% PES 10% LYCRA, 200 g/m², knitted



Colour of Cotton Tablecloths and Napkins



KEY

leyenda / légende / legende

Limited
10-year
warranty

Limited
5-year
warranty

Ten-year or five-year limited warranty for products where expressly indicated on the corresponding catalogue page. For all other products, the European two-year legal guarantee shall apply. **See conditions on www.zown.com/warranty.**

Garantía limitada de 10 o 5 años para aquellos productos en los que así se indique en la correspondiente página del catálogo. Para el resto de productos será aplicable la garantía legal europea de 2 años. **Consultar condiciones en www.zown.com/warranty.**

10 ou 5 ans de garantie limitée pour tous les produits dont la description contient cette indication (veuillez vous reporter à la page correspondante du catalogue). Pour tous les autres produits, c'est la garantie légale européenne de deux ans qui sera appliquée. **Consulter les conditions sur www.zown.com/warranty.**

Auf Waren mit der entsprechenden Angabe auf der jeweiligen Katalogseite leisten wir 10 bzw. 5 Jahre beschränkte Garantie. Für die anderen Waren gilt die gesetzliche europäische Garantiefrist von 2 Jahren. **Bedingungen siehe www.zown.com/warranty.**



High-density polyethylene table top, chair or bench seat and backrest. Powder-coated steel frame.

Sobre de mesa, o asiento y respaldo de silla o banco, en polietileno de alta densidad. Estructura de acero pintado por pulverización.

Plateau de table, ou siège et dossier de chaise ou de banc, en polyéthylène haute densité. Structure en acier peint par pulvérisation.

Tischplatte bzw. Sitzfläche und Rückenlehne von Stuhl bzw. Bank aus HDPE. Gestell aus pulverbeschichtetem Stahl.

Light Grey / Gris Claro / Gris Clair / Hellgrau

White / Blanco / Blanc / Weiß
 Black / Negro / Noir / Schwarz

Brown / Marrón / Marron / Braun
 Green / Verde / Vert / Grün



Powder-coated steel frame. Grey.

Estructura de acero pintado por pulverización. Gris.

Structure en acier peint par pulvérisation. Gris.

Gestell aus pulverbeschichtetem Stahl. Grau.



Polypropylene chair seat and backrest. Powder-coated steel frame.

Asiento y respaldo de la silla de polipropileno. Estructura de acero pintado por pulverización.

Siège et dossier de la chaise en polypropylène. Structure en acier peint par pulvérisation.

Sitzfläche und Rückenlehne des Stuhls aus Polypropylen. Gestell aus pulverbeschichtetem Stahl.

Light Grey / Gris Claro / Gris Clair / Hellgrau
 Grey / Gris / Gris / Grau

Black / Negro / Noir / Schwarz
 Black / Negro / Noir / Schwarz

White / Blanco / Blanc / Weiß
 White / Blanco / Blanc / Weiß



SS304: Stainless steel table.

Mesa de acero inoxidable SS304.

Table en acier inoxydable SS304.

SS304: Tisch aus Edelstahl.

Upholstered seat and backrest. Powder-coated steel frame.

Asiento y respaldo tapizados. Estructura de acero pintado por pulverización.

Siège et dossier rembourrés. Structure en acier peint par pulvérisation.

Sitzfläche und Rückenlehne gepolstert. Gestell aus pulverbeschichtetem Stahl.

Black / Negro / Noir / Schwarz
 Silver / Plata / Argent / Silber

Grey / Gris / Gris / Grau
 Silver / Plata / Argent / Silber

Blue / Azul / Bleu / Blau
 Silver / Plata / Argent / Silber

Red / Rojo / Rouge / Rot
 Silver / Plata / Argent / Silber

Black / Negro / Noir / Schwarz
 Gold / Dorado / Doré / Gold

Black / Negro / Noir / Schwarz
 Black / Negro / Noir / Schwarz



Evenly distributed maximum weight load the table can withstand for 24 hours without causing severe deformation that would prevent its use.

Peso máximo recomendado uniformemente repartido que puede soportar la mesa durante 24h sin causar un grado de deformación severo que impida su uso.

Poids maximum recommandé, réparti de façon uniforme, supporté par la table pendant 24 h sans provoquer de déformation sévère susceptible d'empêcher son utilisation.

Maximal empfohlene Last, der der Tisch bei gleichmäßiger Lastverteilung 24 Stunden lang standhält, ohne starke Verformungen zu erleiden, die seine Einsatztauglichkeit gefährden.



Recommended maximum weight.

Peso máximo recomendado.

Poids maximum recommandé.

Empfohlenes Höchstgewicht.



Net product weight.

Peso neto del producto.

Poids net du produit.

Nettogewicht des Artikels.



UV-protected and water-resistant. Ideal for extensive but not permanent outdoor use.

Protección UV y Hidrófuga. Ideal para uso exterior extensivo, pero no permanente.

Protection UV et hydrofuge. Idéal pour un usage extérieur extensif, mais non permanent.

UV-geschützt und wasserabstoßend. Ideal zur extensiven, aber nicht dauernden Verwendung im Freien.



Seating capacity of the table.

Máximo número recomendado de comensales por mesa.

Nombre maximum recommandé de personnes par table.

Anzahl der Sitzplätze pro Tisch.



Conference table with ergonomic frame.
Mesa para conferencias con estructura ergonómica.
Table pour conférences avec une structure ergonomique.
Konferenztisch mit ergonomischem Gestell.

M183

TABLE MESA TABLE TISCH

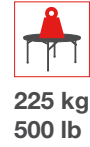

Limited
10-year
warranty

Conference table with wheels, folding table top and modesty panel.
Mesa para conferencias con ruedas, sobre abatible y panel de intimidad.
Table pour conférences à roulettes, surface rabattable et panneau de séparation.
Konferenztisch mit Rädern, klappbarer Tischplatte und Fußraumblende.

oxford180

TABLE MESA TABLE TISCH



thetextilecollection



SPTT-00... Replace (...) with the chosen colour code / Sustituir (...) por el código de color elegido / Remplacer (...) par le code de couleur choisi / (...) durch den gewählten Farbcode ersetzen



Code Código Code Code	EAN	Name Nombre Nom Name	Units per box Unidades por caja Unités par boîte Stückzahl pro Packung	Packaging size Medidas embalaje Dimensions emballage Verpackungsmaße	Packaging volume Volumen embalaje Volume d'emballage Verpackungsvolumen	Gross weight Peso bruto Poids brut Bruttogewicht	Loading quantity Unidades por contenedor Unités par conteneur Einheiten pro Container
PT-033	8436539296577	M183	1	185.4 x 47.6 x 5.7 cm 73" x 18.7" x 2.3"	0.050 m ³ 1.776 ft ³	12.47 kg 27.43 lb	Container 40': 1100 Container 40' HC: 1220

Code Código Code Code	EAN	Name Nombre Nom Name	Units per box Unidades por caja Unités par boîte Stückzahl pro Packung	Packaging size Medidas embalaje Dimensions emballage Verpackungsmaße	Packaging volume Volumen embalaje Volume d'emballage Verpackungsvolumen	Gross weight Peso bruto Poids brut Bruttogewicht	Loading quantity Unidades por contenedor Unités par conteneur Einheiten pro Container
PT-035	8436539296584	oxford180	1	181.9 x 58.4 x 12.7 cm 71.6" x 23" x 5"	0.1349 m ³ 4.763 ft ³	25.29 kg 55.64 lb	Container 40': 446 Container 40' HC: 508

Multi-purpose side table.
Mesa auxiliar multiusos.
Table auxiliaire multi-usages.
Mehrzweck-Beistelltisch.

L120

TABLE MESA TABLE TISCH



8.5 kg
18.7 lb



205 kg
450 lb



Water-resistant



HDPE Light Grey
POWDER-COATED STEEL Grey

Limited
10-year
warranty

Special trolley for the L120 table.
Carro especial para la mesa L120.
Chariot spécial pour la table L120.
Spezialwagen für den Tisch L120.

Ltrolley

TROLLEY CARRO CHARIOT WAGEN



21.3 kg
46.9 lb



POWDER-COATED STEEL Grey

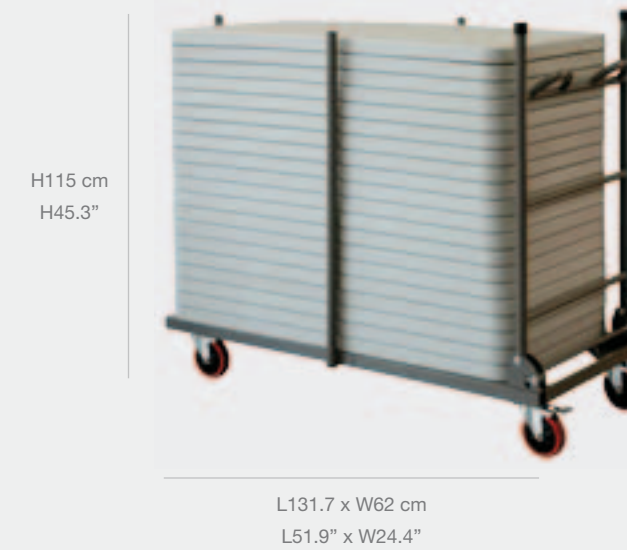
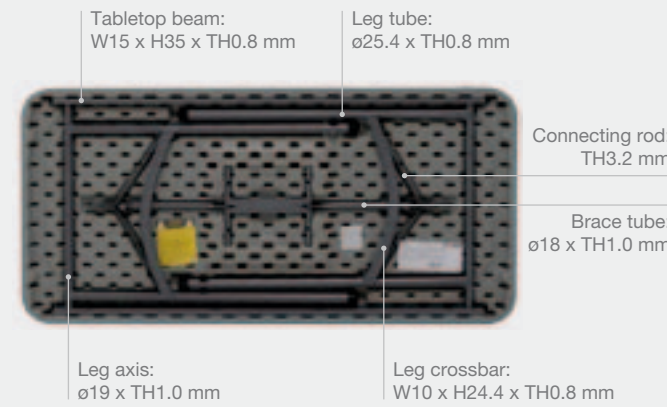

Sliding ring to lock the legs in position when in use. Easy and secure.
Argolla autodeslizante para bloquear las patas en posición de uso. Fácil y seguro.
Anneau autoglissant pour blocage des pieds en position d'usage. Facile et sûr.
Selbstgleitender Metallschiebering zur Feststellung der aufgeklappten Tischbeine. Einfach und sicher.



Ltrolley available for 20 tables. See page 31.
CARRO Ltrolley disponible para 20 mesas. Ver pág. 31.
Chariot Ltrolley disponible pour 20 tables. Voir page 31.
Wagen Ltrolley lieferbar für 20 Tische. Siehe S. 31.



Peripheral posts to hold the stacked tables in place.
Postes périphériques pour immobiliser les tables empilées.
Poteaux périmétraux pour immobiliser des tables empilées.
Sicherungsstangen verhindern das Verrutschen der gestapelten Tische.



Handle specially designed to protect the hands.
Asa especial para proteger las manos.
Anse spécialement conçue pour protéger les mains.
Ein spezieller Griff schützt die Hände.

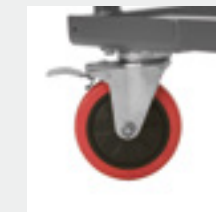

Four polyurethane wheels with built-in brake. (Two fixed wheels and two pivoting wheels).
4 ruedas de poliuretano con freno incorporado (2 ruedas fijas y 2 ruedas pivotantes).
4 roulettes en polyuréthane avec frein intégré. (2 roulettes fixes et 2 roulettes pivotantes).
4 PU-Räder mit integrierter Bremse. (2 feststehende Räder und 2 Schwenkräder).



Capacity: 20 pcs. L120.
Capacidad: 20u. L120.
Capacité: 20u. L120.
Fassungsvermögen: 20 Stk. L120.

thetextilecollection

stretch



SPTT-00...

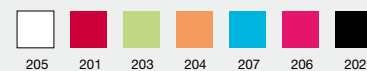

205 201 203 204 207 206 202

paramount



SPTT-00...

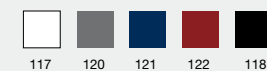

117 120 121 122 118

plain



SPTT-00...

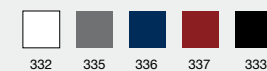

332 335 336 337 333

SPTT-00... Replace (...) with the chosen colour code / Sustituir (...) por el código de color elegido / Remplacer (...) par le code de couleur choisi / (...) durch den gewählten Farbcode ersetzen

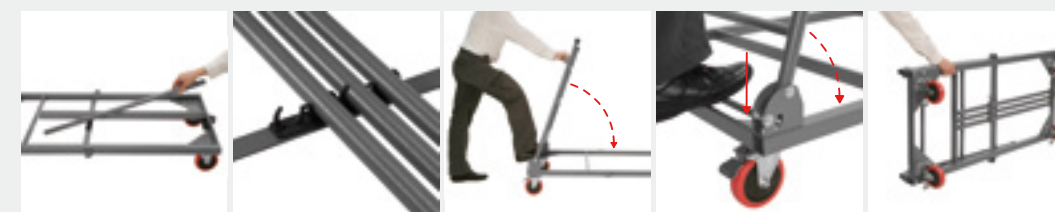

Part to hold the removable posts when folded. Bar with automatic unlocking mechanism which allows the vertical bracket to be folded. Trolley in fully folded position. Occupies a minimum of space. All parts are integrated to prevent loss.

Pieza para sujetar los postes extraíbles en posición de plegado. Barra con mecanismo automático para desbloquear y permitir el plegado del soporte vertical. Carro totalmente plegado. Ocupa mínimo espacio y todos sus componentes quedan integrados para no extraviarlos.

Pièce pour poteaux extractibles en position de pliage. Barre avec mécanisme automatique pour blocage et déblocage et pour permettre le pliage du support vertical. Chariot entièrement plié. Occupe peu de place. Tous ses composants sont intégrés pour ne pas les perdre.

Halterungsvorrichtung für die herausnehmbaren Stangen in abgeklappter Position. Stange mit automatischem Mechanismus zum Entriegeln und Zusammenklappen des senkrechten Gestells. Der Wagen lässt sich vollständig zusammenklappen. Platzsparend sind alle Bestandteile integriert, damit sie nicht verloren gehen.

Code Código Code Code	EAN	Name Nombre Nom Name	Units per box Unidades por caja Unités par boîte Stückzahl pro Packung	Packaging size Medidas embalaje Dimensions emballage Verpackungsmaße	Packaging volume Volumen embalaje Volume d'emballage Verpackungsvolumen	Gross weight Peso bruto Poids brut Bruttogewicht	Loading quantity Unidades por contenedor Unités par conteneur Einheiten pro Container
BT-04B	8437009886151	L120	1	124.8 x 63.5 x 6 cm 49.1" x 25" x 2.4"	0.048 m ³ 1.695 ft ³	9.8 kg 21.56 lb	Container 40': 1270 Container 40' HC: 1500

Code Código Code Code	EAN	Name Nombre Nom Name	Units per box Unidades por caja Unités par boîte Stückzahl pro Packung	Packaging size Medidas embalaje Dimensions emballage Verpackungsmaße	Packaging volume Volumen embalaje Volume d'emballage Verpackungsvolumen	Gross weight Peso bruto Poids brut Bruttogewicht	Loading quantity Unidades por contenedor Unités par conteneur Einheiten pro Container
RA-101A	8437009886014	Ltrolley	1	138.4 x 72.4 x 15.2 cm 54.5" x 28.5" x 6"	0.152 m ³ 5.367 ft ³	23.9 kg 52.5 lb	Container 40': 409 Container 40' HC: 440



XL150

TABLE MESA TABLE TISCH



Limited
10-year
warranty



H74.3 cm
H29.2"

45 mm

L152.4 x W76.2 cm
L5' x W30"

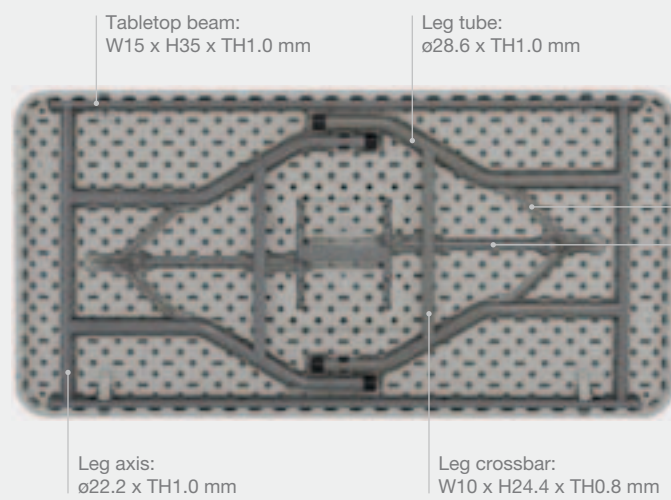

Tabletop beam:
W15 x H35 x TH1.0 mm

Leg tube:
ø28.6 x TH1.0 mm

Connecting rod:
TH2.8 mm

Brace tube:
ø18 x TH1.4 mm

Leg axis:
ø22.2 x TH1.0 mm

Leg crossbar:
W10 x H24.4 x TH0.8 mm

Table with transverse joining system, ideal for 152 x 152 cm square configurations, joining two tables.
Mesa con sistema de unión transversal ideal para composiciones cuadradas de 152 x 152 cm uniendo dos mesas.
Table dotée d'un système de raccord transversal, idéal pour des modules carrés de 152 par 152 cm servant à relier deux tables.
Tisch mit Querverbindungssystem, ideal für eine quadratische Anordnung zweier Tische (152 x 152 cm).

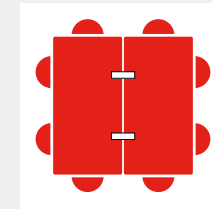

Transverse table joining system.
Sistema de unión transversal de mesas.
Système de raccord transversal de tables.
Vorrichtung zur quersseitigen Verbindung der Tische.

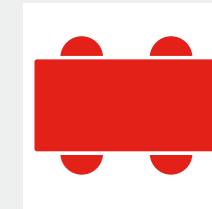

Capacity: 4 persons.
Area per person: 29.9".
Capacidad: 4 personas.
Espacio por persona: 76 cm.
Capacité: 4 personnes.
Espace par personne: 76 cm.
Bietet Platz für 4 Personen.
Platz pro Person: 76 cm.



Capacity: 4 persons.
Area per person: 24".
Capacidad: 4 personas.
Espacio por persona: 61 cm.
Capacité: 4 personnes.
Espace par personne: 61 cm.
Bietet Platz für 4 Personen.
Platz pro Person: 61 cm.

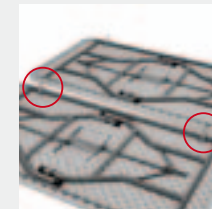

Transverse table joining system.
Sistema de unión transversal de mesas.
Système de raccord transversal de tables.
Vorrichtung zur quersseitigen Verbindung der Tische.



Sliding ring to lock the legs in position when in use. Easy and secure.
Argolla autodeslizante para bloquear las patas en posición de uso. Fácil y seguro.
Anneau autoglissant pour blocage des pieds en position d'usage. Facile et sûr.
Selbstgleitender Metallschieber zur Feststellung der aufgeklappten Tischbeine. Einfach und sicher.



XLtrolley available for 20 tables. See page 44.
CARRO XLtrolley disponible para 20 mesas. Ver pág. 44.
Chariot XLtrolley disponible pour 20 tables. Voir page 44.
Wagen XLtrolley lieferbar für 20 Tische. Siehe S.44.

thetextilecollection

stretch



SPTT-00...

paramount



SPTT-00...

plain



SPTT-00...

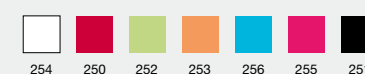

254

250

252

253

256

255

251

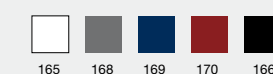

165

168

169

170

166



398

401

402

403

399

SPTT-00... Replace (...) with the chosen colour code / Sustituir (...) por el código de color elegido / Remplacer (...) par le code de couleur choisi / (...) durch den gewählten Farbcode ersetzen

Code Código Code Code	EAN	Name Nombre Nom Name	Units per box Unidades por caja Unités par boîte Stückzahl pro Packung	Packaging size Medidas embalaje Dimensions emballage Verpackungsmaße	Packaging volume Volumen embalaje Volume d'emballage Verpackungsvolumen	Gross weight Peso bruto Poids brut Bruttogewicht	Loading quantity Unidades por contenedor Unités par conteneur Einheiten pro Container
BT-05BK	8437009886168	XL150	1	155.3 x 78 x 6.4 cm 61" x 30.7" x 2.4"	0.077 m ³ 2.719 ft ³	13.15 kg 28.93 lb	Container 40': 850 Container 40' HC: 940

XL180

TABLE MESA TABLE TISCH



14 kg
30.9 lb



315 kg
694 lb



Water-resistant



HDPE
Light Grey
POWDER-COATED
STEEL
Grey

Limited
10-year
warranty



H74.3 cm
H29.2"

45 mm

L182.9 x W75.2 cm
L6' x W29.6"

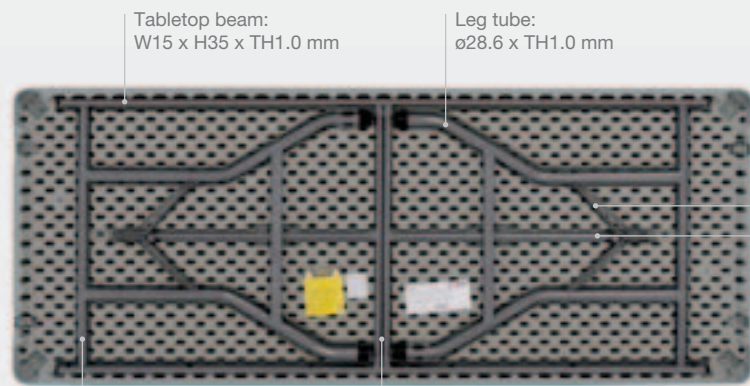

Tabletop beam:
W15 x H35 x TH1.0 mm

Leg tube:
ø28.6 x TH1.0 mm

Connecting rod:
TH2.8 mm

Brace tube:
ø18 x TH1.4 mm

Leg axis:
ø22.2 x TH1.0 mm

Brace axis:
ø18xTH1.4 mm

Table with longitudinal joining system.
Mesa con sistema de unión longitudinal.
Table avec système de raccord longitudinal.
Tisch mit Längsverbindingssystem.

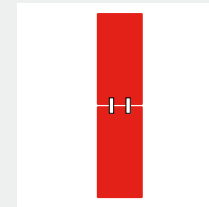

Longitudinal table joining system.

Sistema de unión longitudinal de mesas.

Système de raccord longitudinal de tables.

Vorrichtung zur längsseitigen Verbindung der Tische.

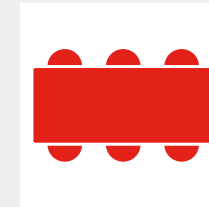

Capacity: 6 persons.
Area per person: 24".

Capacidad: 6 personas.
Espacio por persona: 61 cm.

Capacité: 6 personnes.
Espace par personne: 61 cm.

Bietet Platz für 6 Personen.
Platz pro Person: 61 cm.

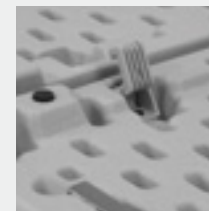

Longitudinal table joining system.

Sistema de unión longitudinal de mesas.

Système de raccord longitudinal de tables.

Vorrichtung zur längsseitigen Verbindung der Tische.



Sliding ring to lock the legs in position when in use. Easy and secure.

Argolla autodeslizante para bloquear las patas en posición de uso. Fácil y seguro.

Anneau autoglissant pour bloquer des pieds en position d'usage. Facile et sûr.

Selbstgleitender Metallschieber zur Feststellung der aufgeklappten Tischbeine. Einfach und sicher.



XLtrolley available for 20 tables. See page 44.

CARRO XLtrolley disponible para 20 mesas. Ver pág. 44.

Chariot XLtrolley disponible pour 20 tables. Voir page 44.

Wagen XLtrolley lieferbar für 20 Tische. Siehe S.44.

thetextilecollection

stretch



SPTT-00...

paramount



SPTT-00...

plain



SPTT-00...

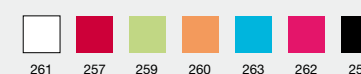

261 257 259 260 263 262 258



171 174 175 176 172

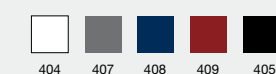

404 407 408 409 405

SPTT-00... Replace (...) with the chosen colour code / Sustituir (...) por el código de color elegido / Remplacer (...) par le code de couleur choisi / (...) durch den gewählten Farbcode ersetzen

Code Código Code Code	EAN	Name Nombre Nom Name	Units per box Unidades por caja Unités par boîte Stückzahl pro Packung	Packaging size Medidas embalaje Dimensions emballage Verpackungsmaße	Packaging volume Volumen embalaje Volume d'emballage Verpackungsvolumen	Gross weight Peso bruto Poids brut Bruttogewicht	Loading quantity Unidades por contenedor Unités par conteneur Einheiten pro Container
BT-06BK	8437009886021	XL180	1	185.4 x 77 x 6.4 cm 73" x 30.6" x 2.5"	0.092 m ³ 3.248 ft ³	16 kg 35.2 lb	Container 40' 700 Container 40' HC: 800

worktop180

TABLE MESA TABLE TISCH



16.9 kg
37.1 lb



270 kg
595 lb



Water-resistant



H74.3 / 85.1 / 90.2 / 94.3 cm
H29.2" / 33.5" / 35.5" / 37.1"



L182.9 x W76.2 cm
L6' x W30"

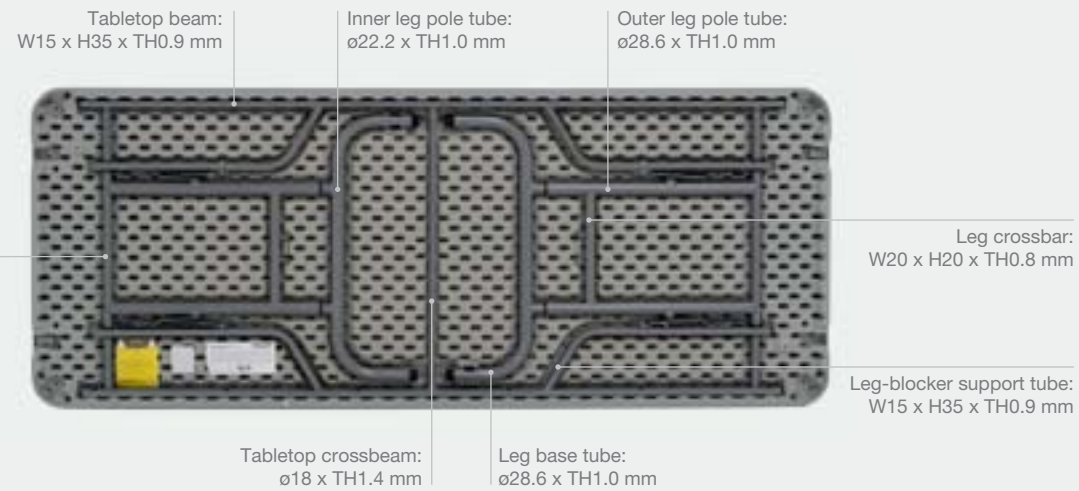

Foldable table height-adjustable in four positions. By selecting its higher positions, it is ideal as a work surface for performing tasks while standing.
Mesa plegable de altura ajustable a 4 posiciones. Seleccionando sus posiciones más altas, resulta ideal como superficie de trabajo para tareas que se realicen estando de pie.
Table pliable à hauteur réglable selon 4 positions. Les positions les plus hautes permettent de s'en servir comme plan de travail, idéal pour réaliser des tâches debout.
Klapptisch, höhenverstellbar in 4 Positionen. Bei Einstellung einer der hohen Positionen ist der Tisch ideal als Arbeitsfläche für stehend ausgeführte Tätigkeiten.

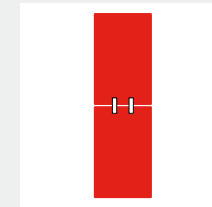

Longitudinal table joining system.
Sistema de unión longitudinal de mesas.
Système de raccord longitudinal de tables.
Vorrichtung zur längseitigen Verbindung der Tische.



Longitudinal table joining system.
Sistema de unión longitudinal de mesas.
Système de raccord longitudinal de tables.
Vorrichtung zur längseitigen Verbindung der Tische.

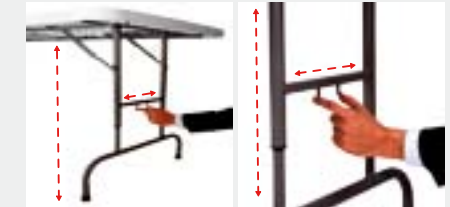

Practical mechanism for adjusting the table height.
Práctico mecanismo para ajustar la altura de la mesa.
Mécanisme pratique pour régler la hauteur de la table.
Praktische Vorrichtung zum Einstellen der Tischhöhe.

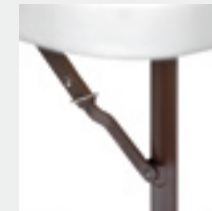

Manual lock (1) and sliding ring (2) for greater leg stability when in use.
Bloqueador manual (1) y argolla autodeslizante (2) para mayor seguridad de las patas en posición de uso.
Blocage manuel (1) et anneau autoglissant (2) pour plus de sécurité des pieds en position d'usage.
Manuelle Feststellung (1) und selbstgleitender Metallschiebering (2) für eine höhere Sicherheit der Tischbeine in aufgeklappter Position.



XLtrolley available for 20 tables. See page 44.
Carro XLtrolley disponible para 20 mesas. Ver pág. 44.
Chariot XLtrolley disponible pour 20 tables. Voir page 44.
Wagen XLtrolley lieferbar für 20 Tische. Siehe S. 44.



Ideal as a work surface.
Ideal como superficie de trabajo.
Idéal comme plan de travail.
Ideal als Arbeitsfläche.

thetextilecollection

stretch



SPTT-00...

paramount



SPTT-00...

plain



SPTT-00...

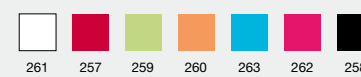

261 257 259 260 263 262 258

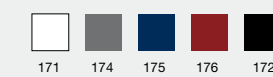

171 174 175 176 172



404 407 408 409 405

SPTT-00... Replace (...) with the chosen colour code / Sustituir (...) por el código de color elegido / Remplacer (...) par le code de couleur choisi / (...) durch den gewählten Farbcode ersetzen
Válido para mesa worktop180 en altura 74.3 cm/29.2" / Válido para mesa worktop180 en altura 74.3 cm/29.2" / Válido para mesa worktop180 en altura 74.3 cm/29.2" / Válido para mesa worktop180 en altura 74.3 cm/29.2"

Table with wheels and bottom rack for storage. It can be turned into a buffet table by joining it to the "Top Shelf" model.
 Mesa con ruedas y estante inferior para almacenaje. Puede convertirse en una mesa buffet acoplándole un "Top Shelf".
 Table à roulettes avec une étagère de rangement dans la partie inférieure. Elle peut se transformer en table de buffet au moyen d'un « Top Shelf ».
 Tisch mit Rädern und Unterregal zur Ablage. Kann in Verbindung mit einem „Top Shelf“ in einen Büfett-Tisch verwandelt werden.

buffettablebase

TABLE MESA TABLE TISCH



19.15 kg
42.13 lb



150 kg
330 lb



Water-resistant



Limited
10-year
warranty

Upper shelf to be attached to the tables: XL180, Buffet base, Worktop180 to turn them into buffet tables.
 Estante superior para ser unido a las mesas: XL180, Buffet base, Worktop180 para convertirlas en una mesa-buffet.
 Étagère supérieure destinée à être reliée aux tables suivantes : XL180, Buffet base, Worktop180, pour en faire des tables de buffet.
 Oberregal zur Verbindung mit den Tischen XL180, Büfett-Basis und Worktop180 zur Umwandlung in einen Büfett-Tisch.

topshelf180

SHELF ESTANTE SHELF SHELF



7.2 kg
15.87 lb



70 kg
155 lb



Water-resistant



Ideal for displaying food in buffet services.
 Ideal para la disposición de alimentos en servicios de buffet.
 Idéal pour disposer différents plats lors d'un buffet.
 Ideal zum Anrichten von Speisen für Büfettts.



Ideal para ser utilizado como mostrador de bar.
 Peut également être utilisée comme comptoir de bar.
 Ideal zur Verwendung als Bar-Theke.

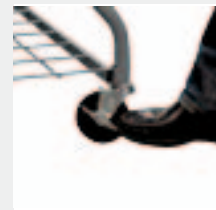

4 wheels with integrated brakes.
 4 ruedas con freno incorporado.
 4 roulettes avec frein.
 4 Räder mit integrierter Bremse.



Upper shelf that can be attached to an Buffet table base, XL180table, Sharp180table and the Worktop180 in order to turn the regular table into a buffet-table.
 Estante superior para ser unido a las mesas Buffet table base, XL180, Sharp180 y Worktop180 para convertirla en una mesa-buffet.
 Tablette supplémentaire avec système d'accroche pour monter les tables Buffet table base, XL180, Sharp180 et Worktop180 en buffet.
 Tischaufsatz für Tisch Buffet table base, XL180, Verwandelt den XL180, Sharp180 und Worktop180 Tischen in einen Büfettisch.

thetextilecollection

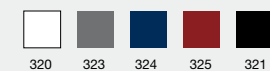

SPTT-00... Replace (...) with the chosen colour code / Sustituir (...) por el código de color elegido / Remplacer (...) par le code de couleur choisi / (...) durch den gewählten Farbcode ersetzen

thetextilecollection

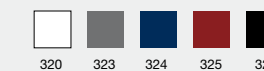

SPTT-00... Replace (...) with the chosen colour code / Sustituir (...) por el código de color elegido / Remplacer (...) par le code de couleur choisi / (...) durch den gewählten Farbcode ersetzen

Code Código Code Code	EAN	Name Nombre Nom Name	Units per box Unidades por caja Unités par boîte Stückzahl pro Packung	Packaging size Medidas embalaje Dimensions emballage Verpackungsmaße	Packaging volume Volumen embalaje Volume d'emballage Verpackungsvolumen	Gross weight Peso bruto Poids brut Bruttogewicht	Loading quantity Unidades por contenedor Unités par conteneur Einheiten pro Container
PT010X002	8436539297413	buffettablebase	1	192.7 x 77.4 x 8.5 cm 75.8" x 30.5" x 3.3"	0.128 m³ 4.520 ft³	21.99 kg 48.38 lb	Container 40': 468 Container 40' HC: 520

Code Código Code Code	EAN	Name Nombre Nom Name	Units per box Unidades por caja Unités par boîte Stückzahl pro Packung	Packaging size Medidas embalaje Dimensions emballage Verpackungsmaße	Packaging volume Volumen embalaje Volume d'emballage Verpackungsvolumen	Gross weight Peso bruto Poids brut Bruttogewicht	Loading quantity Unidades por contenedor Unités par conteneur Einheiten pro Container
PT-26	8436539292470	topshelf180	1	197 x 32 x 6 cm 77.5" x 12.75" x 2.4"	0.037 m³ 1.334 ft³	8.5 kg 18.73 lb	Container 40': 1612 Container 40' HC: 1792

XL240

TABLE MESA TABLE TISCH



Limited
10-year
warranty

Table for eight diners.
Mesa para ocho comensales.
Table conçue pour huit personnes.
Tisch für acht Personen.

H74.3 cm
H29.2"



L243.8 x W76.2 cm
L8' x W30"

50.8 mm

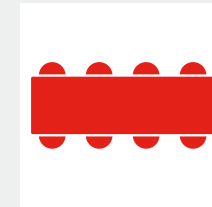
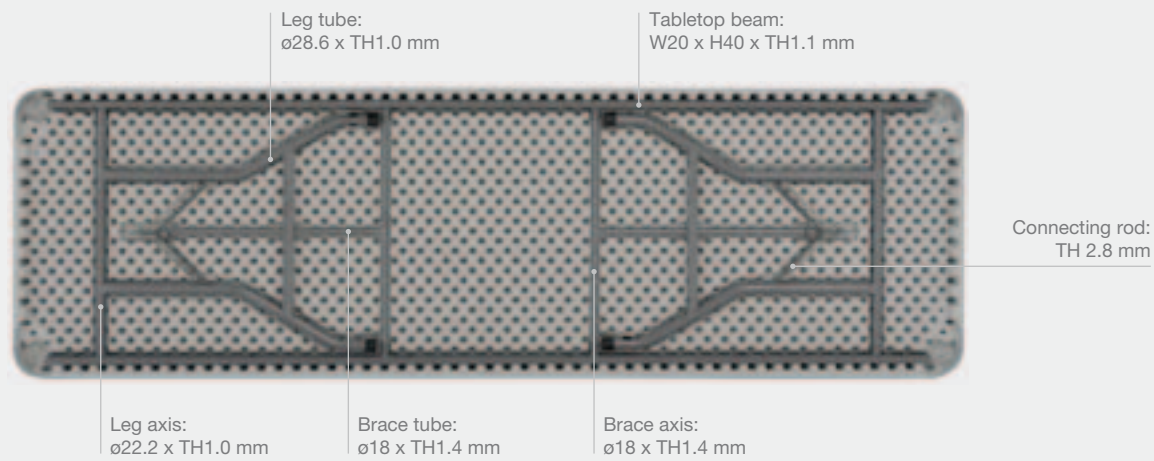

Capacity: 8 persons.
Area per person: 24".
Capacidad: 8 personas.
Espacio por persona: 61 cm.
Capacité: 8 personnes.
Espace par personne: 61 cm.
Bietet Platz für 8 Personen.
Platz pro Person: 61 cm.

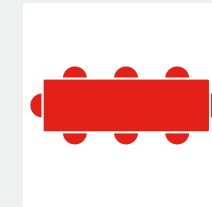

Capacity: 8 persons.
Area per person: 24".
Capacidad: 8 personas.
Espacio por persona: 61 cm.
Capacité: 8 personnes.
Espace par personne: 61 cm.
Bietet Platz für 8 Personen.
Platz pro Person: 61 cm.



Sliding ring to lock the legs in position when in use. Easy and secure.
Argolla autodeslizante para bloquear las patas en posición de uso. Fácil y seguro.
Anneau autoglissant pour blocage des pieds en position d'usage. Facile et sûr.
Selbstgleitender Metallschieber zur Feststellung der aufgeklappten Tischbeine. Einfach und sicher.



XLtrolley available for 18 tables. See page 44.
CARRO XLtrolley disponible para 18 mesas. Ver pág. 44.
Chariot XLtrolley disponible pour 18 tables. Voir page 44.
Wagen XLtrolley lieferbar für 18 Tische. Siehe S.44.

thetextilecollection

stretch



SPTT-00...

paramount



SPTT-00...

plain



SPTT-00...

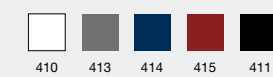
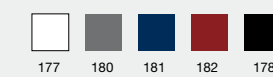
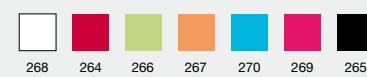

SPTT-00... Replace (...) with the chosen colour code / Sustituir (...) por el código de color elegido / Remplacer (...) par le code de couleur choisi / (...) durch den gewählten Farbcode ersetzen

Code Código Code Code	EAN	Name Nombre Nom Name	Units per box Unidades por caja Unités par boîte Stückzahl pro Packung	Packaging size Medidas embalaje Dimensions emballage Verpackungsmaße	Packaging volume Volumen embalaje Volume d'emballage Verpackungsvolumen	Gross weight Peso bruto Poids brut Bruttogewicht	Loading quantity Unidades por contenedor Unités par conteneur Einheiten pro Container
BT-08B	8437009886175	XL240	1	247.3 x 78 x 7.1 cm 97.4" x 30.6" x 2.8"	0.138 m ³ 4.873 ft ³	22 kg 48.4 lb	Container 40': 384 Container 40' HC: 540

Folding trolley with extendable base. Suitable for the XL150, XL180, XL240 and Worktop180 tables.
 Carro plegable con base extensible. Apto para las mesas XL150, XL180, XL240, Worktop180.
 Chariot pliant avec une base extensible. Compatible avec les tables XL150, XL180, XL240 et Worktop180.
 Klappwagen mit ausziehbarer Ladefläche. Geeignet für die Tische XL150, XL180, XL240, Worktop180.

XLtrolley

TROLLEY CARRO CHARIOT WAGEN



29.58 kg
65.22 lb



H115 cm
H45.3"



L(193 + 61) x W77 cm
L(76" + 24") x W30.3"



Peripheral posts to hold the stacked tables in place.

Postes périphériques pour immobiliser les tables empilées.

Poteaux périmétraux pour immobiliser les tables empilées.

Sicherungsstangen verhindern das Verrutschen der gestapelten Tische.

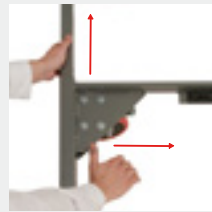

Expandable base to adjust to the respective table lengths.

Base extensible para adecuarla a la longitud de las distintas mesas.

Base extensible pour une adaptation à la longueur des différentes tables.

Die ausziehbare Ladefläche lässt sich an die jeweilige Tischlänge anpassen.



Handle specially designed to protect the hands.

Anse spécialement conçue pour protéger les mains.

Ein spezieller Griff schützt die Hände.

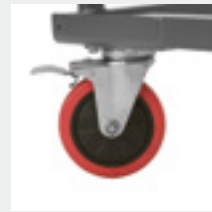

Four polyurethane wheels with built-in brake. (Two fixed wheels and two pivoting wheels).

4 ruedas de poliuretano con freno incorporado (2 ruedas fijas y 2 ruedas pivotantes).

4 roulettes en polyuréthane avec frein intégré. (2 roulettes fixes et 2 roulettes pivotantes).

4 PU-Räder mit integrierter Bremse. (2 feststehende Räder und 2 Schwenkräder).



Capacity: 20 pcs. XL150, 20 pcs. XL180, 20 pcs. worktop180, 18 pcs. XL240.

Capacidad: 20u. XL150, 20u. XL180, 20 pcs. worktop180, 18u. XL240.

Capacité: 20u. XL150, 20u. XL180, 20 pcs. worktop180, 18u. XL240.

Fassungsvermögen: 20 Stk. XL150, 20 Stk. XL180, 20 Stk. worktop180, 18 Stk. XL240.



Part to hold the removable posts when folded. Bar with automatic unlocking mechanism which allows the vertical bracket to be folded. Trolley in fully folded position. Occupies a minimum of space. All parts are integrated to prevent loss.

Pieza para sujetar los postes extraíbles en posición de plegado. Barra con mecanismo automático para desbloquear y permitir el plegado del soporte vertical. Carro totalmente plegado. Ocupa mínimo espacio y todos sus componentes quedan integrados para no extraviarlos.

Pièce pour les poteaux extractibles en position de pliage. Barre avec mécanisme automatique pour blocage et déblocage et pour permettre le pliage du support vertical. Chariot entièrement plié. Occupe peu de place. Tous ses composants sont intégrés pour ne pas les perdre.

Halterungsvorrichtung für die herausnehmbaren Stangen in abgeklappter Position. Stange mit automatischem Mechanismus zum Entriegeln und Zusammenklappen des senkrechten Gestells. Der Wagen lässt sich vollständig zusammenklappen. Platzsparend sind alle Bestandteile integriert, damit sie nicht verloren gehen.

Code Código Code Code	EAN	Name Nombre Nom Name	Units per box Unidades por caja Unités par boîte Stückzahl pro Packung	Packaging size Medidas embalaje Dimensions emballage Verpackungsmaße	Packaging volume Volumen embalaje Volume d'emballage Verpackungsvolumen	Gross weight Peso bruto Poids brut Bruttogewicht	Loading quantity Unidades por contenedor Unités par conteneur Einheiten pro Container
RA-102A	8437009886038	XLtrolley	1	198.1 x 87 x 15.2 cm 78" x 34.2" x 6"	0.262 m ³ 9.252 ft ³	35.35 kg 77.95 lb	Container 40': 229 Container 40' HC: 255



XLmoon

TABLE MESA TABLE TISCH

3-4
18.6 kg
41 lb
300 kg
661 lb
 Water-resistant
 HDPE Light Grey
 POWDER-COATED STEEL Grey

Limited
10-year
warranty

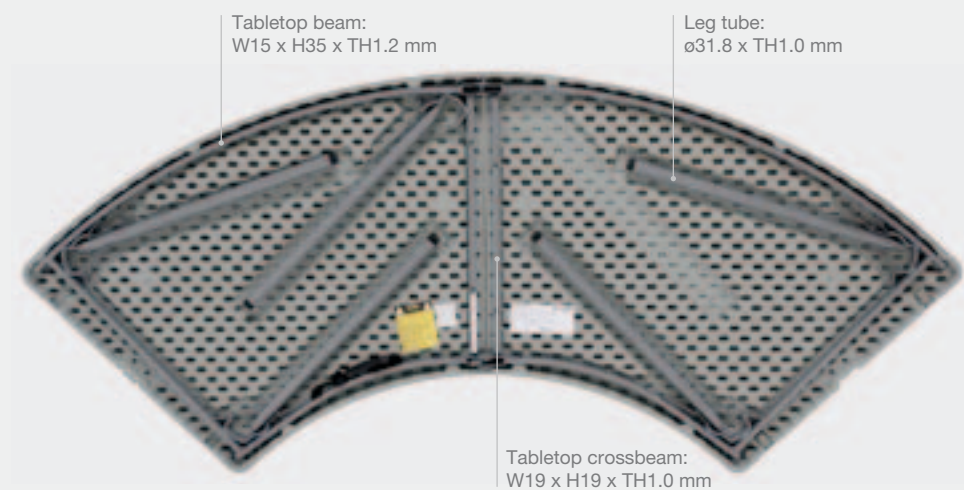
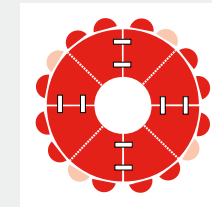

Table with circular joining system. It allows several configurations by combining it with "XL" tables or the Planet**180** table.
 Mesa con sistema de unión circular. Permite varias composiciones combinándola con mesas rectangulares "XL" o con la mesa Planet**180**.
 Table avec système de raccord circulaire. Elle permet plusieurs compositions, avec des tables rectangulaires « XL » ou avec la table Planet**180**.
 Tisch mit Kreisverbindungssystem. Ermöglicht verschiedene Anordnungen durch Kombination mit den rechteckigen XL-Tischen bzw. dem Tisch Planet**180**.



Circular joining of four XLmoon tables with 1 planet**180** table. Capacity for 12 to 16 persons.

Unión circular de 4 mesas XLmoon con 1 mesa planet**180**. Capacidad 12 a 16 personas.

Raccord circulaire de 4 tables XLmoon avec 1 table planet**180**. Capacité 12 à 16 personnes.

Kreisförmige Verbindung von 4 Tischen XLmoon mit einem Tisch planet**180**. Bietet Platz für 12 bis 16 Personen.

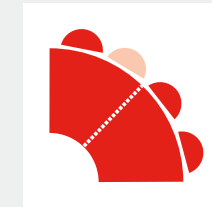

Capacity: 3 or 4 persons. Area per person: 34" or 25".

Capacidad: 3 o 4 personas. Espacio por persona: 87 o 65 cm.

Capacité: 3 ou 4 personnes. Espace par personne: 87 ou 65 cm.

Bietet Platz für 3 oder 4 Personen. Platz pro Person: 87 oder 65 cm.



Angular or circular table joining system.

Sistema de unión angular o circular de mesas.

Système de raccord d'angle ou raccord circulaire de tables.

Vorrichtung zur winkel- und kreisförmigen Verbindung von Tischen.



Automatic leg lock when in use.

Bloqueador automático de patas en posición de uso.

Blocage automatique des pieds en position d'usage.

Automatische Feststellung der aufgeklappten Tischbeine.



Height adjusters on 5 legs.

Regulador de altura en las 5 patas.

Régulateur de hauteur sur les 5 pieds.

Integrierte Höhenverstellung in den 5 Tischbeinen.



Folding table top. Table provided with carrying handle.

Sobre plegable. Mesa provista de un asa.

Surface pliable. Table munie d'une anse.

Der zusammengeklappte Tisch hat einen Tragegriff.

thetextilecollection

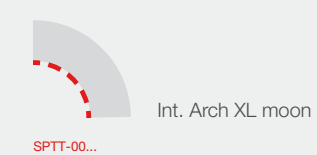
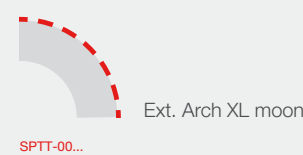

paramount

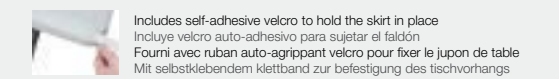
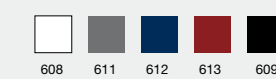
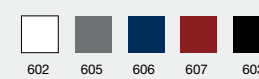

SPTT-00... Replace (...) with the chosen colour code / Sustituir (...) por el código de color elegido / Remplacer (...) par le code de couleur choisi / (...) durch den gewählten Farbcode ersetzen

Code Código Code Code	EAN	Name Nombre Nom Name	Units per box Unidades por caja Unités par boîte Stückzahl pro Packung	Packaging size Medidas embalaje Dimensions emballage Verpackungsmaße	Packaging volume Volumen embalaje Volume d'emballage Verpackungsvolumen	Gross weight Peso bruto Poids brut Bruttogewicht	Loading quantity Unidades por contenedor Unités par conteneur Einheiten pro Container
PT-34	8437009886182	XLmoon	1	129.8 x 84.6 x 12 cm 51.1" x 33.3" x 4.7"	0.132 m ³ 4.661 ft ³	20.1 kg 44.22 lb	Container 40': 460 Container 40' HC: 520

Table with angular joining system. It allows several configurations by combining it with rectangular "XL" tables.
 Mesa con sistema de unión angular. Permite varias composiciones combinándola con mesas rectangulares "XL".
 Table avec système de raccord d'angle. Elle permet différentes compositions avec des tables rectangulaires « XL ».
 Tisch mit Eckverbindungssystem. Ermöglicht verschiedene Anordnungen durch Kombination mit den rechteckigen XL-Tischen.

XLcorner

TABLE MESA TABLE TISCH



Limited
10-year
 warranty

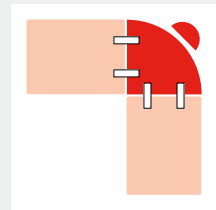

Capacity: 1 person.
 Area per person: 47".
 Capacidad: 1 persona.
 Espacio por persona: 119.4 cm.
 Capacité: 1 personne.
 Espace par personne: 119.4 cm.
 Bietet Platz für 1 Person.
 Platz pro Person: 119.4 cm.



Angular table joining system.
 Sistema de unión angular de mesas.
 Système de raccord d'angle de tables.
 Vorrichtung zur winkelförmigen Verbindung von Tischen.



Automatic leg lock when in use.
 Bloqueador automático de patas en posición de uso.
 Blocage automatique des pieds en position d'usage.
 Automatische Feststellung der aufgeklappten Tischbeine.



Height adjuster on 3 legs.
 Regulador de altura incorporado en las 3 patas.
 Régulateur de hauteur intégré aux 3 pieds.
 Integrierte Höhenverstellung in den 3 Tischbeinen.



Telescopic leg for optimal folding.
 Una pata telescópica para permitir un óptimo plegado.
 Pied télescopique permettant un pliage optimal.
 Ein zusammenschiebares Tischbein ermöglicht ein optimales Zusammenklappen.

thetextilecollection

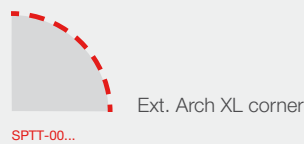

SPTT-00...

paramount



Includes self-adhesive velcro to hold the skirt in place
 Incluye velcro auto-adhesivo para sujetar el faldón
 Fourni avec ruban auto-agrippant velcro pour fixer le jupon de table
 Mit selbstklebendem Klettband zur Befestigung des Tischvorhangs

SPTT-00... Replace (...) with the chosen colour code / Sustituir (...) por el código de color elegido / Remplacer (...) par le code de couleur choisi / (...) durch den gewählten Farbcode ersetzen

Code Código Code Code	EAN	Name Nombre Nom Name	Units per box Unidades por caja Unités par boîte Stückzahl pro Packung	Packaging size Medidas embalaje Dimensions emballage Verpackungsmaße	Packaging volume Volumen embalaje Volume d'emballage Verpackungsvolumen	Gross weight Peso bruto Poids brut Bruttogewicht	Loading quantity Unidades por contenedor Unités par conteneur Einheiten pro Container
PT-32	8437009886045	XLcorner	2	78.1 x 76.8 x 14 cm 30.7" x 30.2" x 5.5"	0.083 m ³ 2.931 ft ³	14.6 kg 32.18 lb	Container 40': 1456 Container 40' HC: 1640



Square table with ergonomic legs.
 Mesa cuadrada con patas ergonómicas.
 Table carrée avec pieds ergonomiques.
 Quadratischer Tisch mit ergonomischen Füßen.

XXL90

TABLE MESA TABLE TISCH



Limited
10-year
 warranty

H74.3 cm
 H29.2"



L91.4 x W91.4 cm
 L36" x W36"

Tabletop beam:
 W15 x H30 x TH1.0 mm

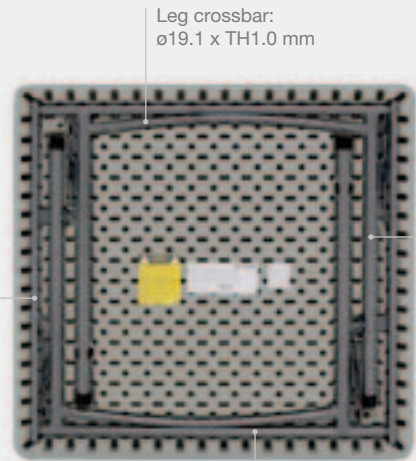

Leg crossbar:
 ø19.1 x TH1.0 mm

Leg tube:
 ø28.6 x TH1.0 mm

Leg axis tube:
 ø22.2 x TH1.0 mm

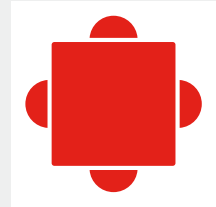

Capacity: 4 persons.
 Area per person: 24".
 Capacidad: 4 personas.
 Espacio por persona: 61 cm.
 Capacité: 4 personnes.
 Espace par personne: 61 cm.
 Bietet Platz für 4 Personen.
 Platz pro Person: 61 cm.



Ergonomic crosspieces for greater comfort.
 Travesaños ergonómicos para un mayor confort.
 Traverses ergonomiques pour plus de confort.
 Ergonomische Querstrebe für mehr Bequemlichkeit.

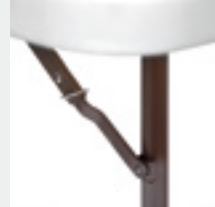

Manual lock (1) and sliding ring (2) for greater leg stability when in use.
 Bloqueador manual (1) y argolla autodeslizante (2) para mayor seguridad de las patas en posición de uso.
 Blocage manuel (1) et anneau autoglissant (2) pour plus de sécurité des pieds en position d'usage.
 Manuelle Feststellung (1) und selbstgleitender Metallschieber (2) für eine höhere Sicherheit der Tischbeine in aufgeklappter Position.



Trolley available for 28 tables (2 stacks of 14 tables). See page 57.
 Carro disponible para 28 mesas (2 pilas de 14 mesas). Ver pág. 57.
 Chariot disponible pour 28 tables (2 piles de 14 tables). Voir page 57.
 Wagen für 28 Tische. (2 Stapel mit jeweils 14 Tischen). Siehe S.57.

thetextilecollection

stretch



SPTT-00...



paramount



SPTT-00...



plain



SPTT-00...



SPTT-00... Replace (...) with the chosen colour code / Sustituir (...) por el código de color elegido / Remplacer (...) par le code de couleur choisi / (...) durch den gewählten Farbcode ersetzen

Code Código Code Code	EAN	Name Nombre Nom Name	Units per box Unidades por caja Unités par boîte Stückzahl pro Packung	Packaging size Medidas embalaje Dimensions emballage Verpackungsmaße	Packaging volume Volumen embalaje Volume d'emballage Verpackungsvolumen	Gross weight Peso bruto Poids brut Bruttogewicht	Loading quantity Unidades por contenedor Unités par conteneur Einheiten pro Container
BT-36	8437009886199	XXL90	1	93.4 x 94 x 6.4 cm 36.7" x 37" x 2.5"	0.056 m³ 1.977 ft³	11.8 kg 25.96 lb	Container 40': 1076 Container 40' HC: 1204



XXL200

TABLE MESA TABLE TISCH

6
 19.5 kg / 42.9 lb
 350 kg / 772 lb
 Water-resistant
 HDPE Light Gray
 POWDER-COATED STEEL Gray

Limited 10-year warranty



L198.2 x W91.4 cm
L6.5' x W36\"/>

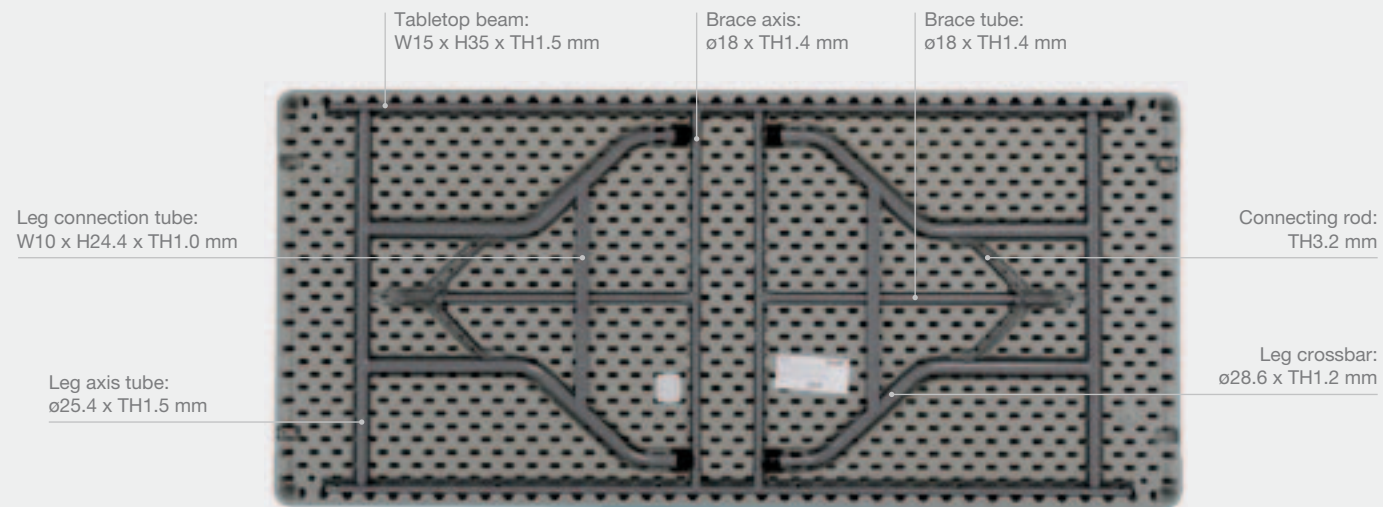

Rectangular table with extra depth for greater comfort and longitudinal joining system.
 Mesa rectangular con profundidad extra para mayor confort y con sistema de unión longitudinal.
 Table rectangulaire plus large pour un plus grand confort, avec un système de raccord longitudinal.
 Extra tiefer, rechteckiger Tisch für höheren Komfort, mit Längsverbindingssystem.

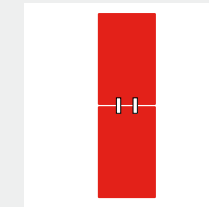

Longitudinal table joining system.
 Sistema de unión longitudinal de mesas.
 Système de raccord longitudinal de tables.
 Vorrichtung zur längseitigen Verbindung der Tische.



Capacity: 6 persons.
 Area per person: 26\"/>

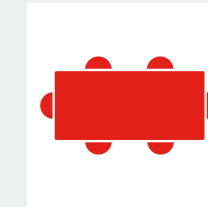

Capacity: 6 persons.
 Area per person: 27\"/>



Longitudinal table joining system.
 Sistema de unión longitudinal de mesas.
 Système de raccord longitudinal de tables.
 Vorrichtung zur längseitigen Verbindung der Tische.



Sliding ring to lock the legs in position when in use. Easy and secure.
 Argolla autodeslizante para bloquear las patas en posición de uso. Fácil y seguro.
 Anneau autoglissant pour blocage des pieds en position d'usage. Facile et sûr.
 Selbstgleitender Metallschieber zur Feststellung der aufgeklappten Tischbeine. Einfach und sicher.



Trolley available for 18 tables. See page 57.
 Carro disponible para 18 mesas. Ver pág. 57.
 Chariot disponible pour 18 tables. Voir page 57.
 Wagen für 18 Tische lieferbar. Siehe S. 57.

the textile collection

stretch



SPTT-00...

paramount



SPTT-00...

plain



SPTT-00...

Code Código Code Code	EAN	Name Nombre Nom Name	Units per box Unidades por caja Unités par boîte Stückzahl pro Packung	Packaging size Medidas embalaje Dimensions emballage Verpackungsmaße	Packaging volume Volumen embalaje Volume d'emballage Verpackungsvolumen	Gross weight Peso bruto Poids brut Bruttogewicht	Loading quantity Unidades por contenedor Unités par conteneur Einheiten pro Container
PT-29	8437009886052	XXL200	1	200.7 x 93.7 x 6.4 cm 79" x 36.9" x 2.5"	0.120 m ³ 4.237 ft ³	23 kg 50.6 lb	Container 40': 516 Container 40' HC: 576

275	271	273	274	277	276	272	183	186	187	188	184	416	419	420	421	417

SPTT-00... Replace (...) with the chosen colour code / Sostituire (...) per el código de color elegido / Remplacer (...) par le code de couleur choisi / (...) durch den gewählten Farbcode ersetzen

XXL240

TABLE MESA TABLE TISCH

8
 25.3 kg / 55.8 lb
 350 kg / 772 lb
 Water-resistant
 HDPE Light Grey POWDER-COATED STEEL Grey

Limited 10-year warranty



H74.3 cm
H29.2"

51 mm

L240 x W91.4 cm
L8' x W36"

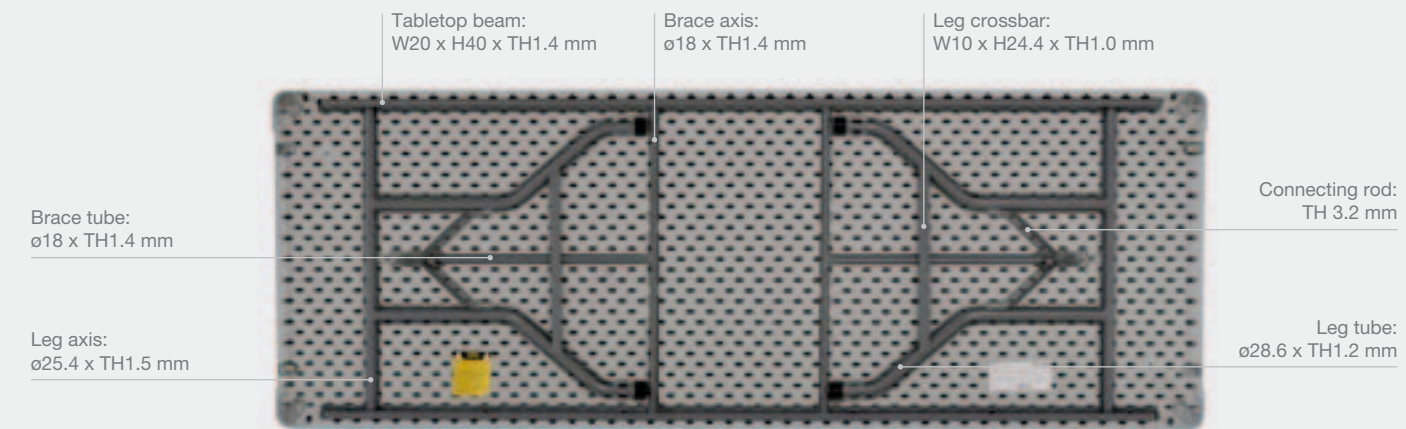

Rectangular table with extra depth for greater comfort and longitudinal joining system.
 Mesa rectangular con profundidad extra para mayor confort y con sistema de unión longitudinal.
 Table rectangulaire plus large pour un plus grand confort, avec un système de raccord longitudinal.
 Extra tiefer, rechteckiger Tisch für höheren Komfort, mit Längsverbindingssystem.

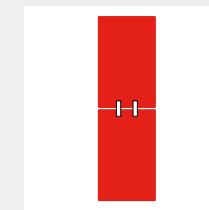

Longitudinal table joining system.
 Sistema de unión longitudinal de mesas.
 Système de raccord longitudinal de tables.
 Vorrichtung zur längseitigen Verbindung der Tische.

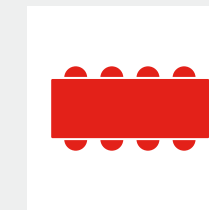

Capacity: 8 persons.
 Area per person: 24".
 Capacidad: 8 personas.
 Espacio por persona: 61 cm.
 Capacité: 8 personnes.
 Espace par personne: 61 cm.
 Bietet Platz für 8 Personen.
 Platz pro Person: 61 cm.

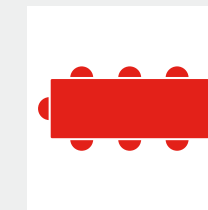

Capacity: 8 persons.
 Area per person: 24".
 Capacidad: 8 personas.
 Espacio por persona: 61 cm.
 Capacité: 8 personnes.
 Espace par personne: 61 cm.
 Bietet Platz für 8 Personen.
 Platz pro Person: 61 cm.



Longitudinal table joining system.
 Sistema de unión longitudinal de mesas.
 Système de raccord longitudinal de tables.
 Vorrichtung zur längseitigen Verbindung der Tische.



Sliding ring to lock the legs in position when in use. Easy and secure.
 Argolla autodeslizante para bloquear las patas en posición de uso. Fácil y seguro.
 Anneau autoglissant pour blocage des pieds en position d'usage. Facile et sûr.
 Selbstgleitender Metallschieber zur Feststellung der aufgeklappten Tischbeine. Einfach und sicher.



Trolley available for 15 tables. See page 57.
 Carro disponible para 15 mesas. Ver pág. 57.
 Chariot disponible pour 15 tables. Voir page 57.
 Wagen für 15 Tische lieferbar. Siehe S. 57.

thetextilecollection

stretch



SPTT-00...

paramount



SPTT-00...

plain



SPTT-00...

Code Código Code Code	EAN	Name Nombre Nom Name	Units per box Unidades por caja Unités par boîte Stückzahl pro Packung	Packaging size Medidas embalaje Dimensions emballage Verpackungsmaße	Packaging volume Volumen embalaje Volume d'emballage Verpackungsvolumen	Gross weight Peso bruto Poids brut Bruttogewicht	Loading quantity Unidades por contenedor Unités par conteneur Einheiten pro Container
PT-31	8437009886205	XXL240	1	242.6 x 93.7 x 7 cm 95.5" x 36.9" x 2.7"	0.159 m ³ 5.615 ft ³	28.4 kg 62.48 lb	Container 40': 370 Container 40' HC: 440

282	278	280	281	284	283	279	189	192	193	194	190	422	425	426	427	423

SPTT-00... Replace (...) with the chosen colour code / Sostituire (...) per el código de color elegido / Remplacer (...) par le code de couleur choisi / (...) durch den gewählten Farbcode ersetzen

Table with angular joining system. It allows several configurations by combining it with rectangular "XXL" tables.
 Mesa con sistema de unión angular. Permite varias composiciones combinándola con mesas rectangulares "XXL".
 Table avec système de raccord d'angle. Elle permet différentes compositions avec des tables rectangulaires « XXL ».
 Tisch mit Eckverbindungssystem. Ermöglicht verschiedene Anordnungen durch Kombination mit den rechteckigen XXL-Tischen.

XXLcorner

TABLE MESA TABLE TISCH



Limited
10-year
warranty



XXLtrolley

TROLLEY CARRO CHARIOT WAGEN

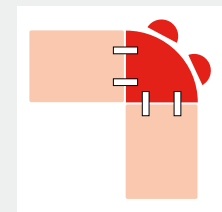
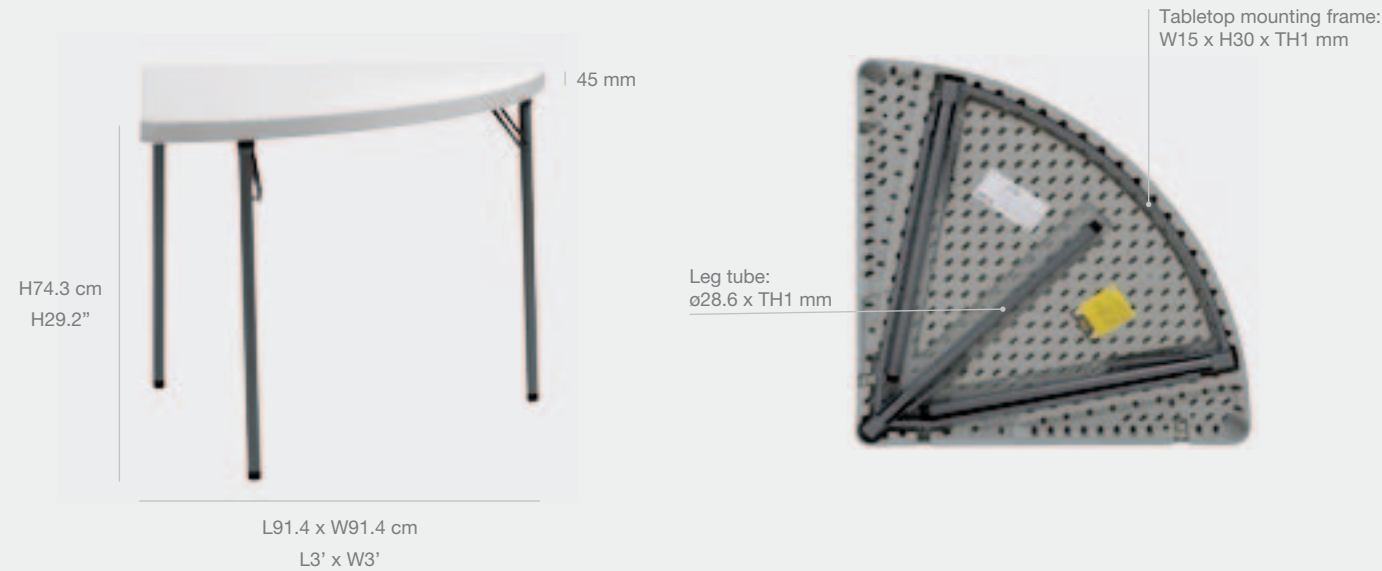

Capacity: 2 persons.
Area per person: 28".
Capacidad: 2 personas.
Espacio por persona: 71.5 cm.
Capacité: 2 personnes.
Espace par personne: 71.5 cm.
Bietet Platz für 2 Personen.
Platz pro Person: 71.5 cm.



Angular table joining system.
Sistema de unión angular de mesas.
Système de raccord d'angle de tables.
Vorrichtung zur winkelförmigen Verbindung von Tischen.



Automatic leg lock when in use.
Bloqueador automático de patas en posición de uso.
Blocage automatique des pieds en position d'usage.
Automatische Feststellung der aufgeklappten Tischbeine.



Height adjuster on 3 legs.
Regulador de altura incorporado en las 3 patas.
Régulateur de hauteur intégré aux 3 pieds.
Integrierte Höhenverstellung in den 3 Tischbeinen.



Peripheral posts to hold the stacked tables in place.
Postes périphériques pour immobiliser les tables empilées.
Sicherungsstangen verhindern das Verrutschen der gestapelten Tische.



Expandable base to adjust to the respective table lengths.
Base extensible para adecuarla a la longitud de las distintas mesas.
Base extensible pour une adaptation à la longueur des différentes tables.
Die ausziehbare Ladefläche lässt sich an die jeweilige Tischlänge anpassen.

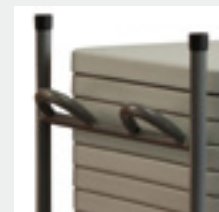

Special handle designed to protect the hands.
Asa especial para proteger las manos.
Anse spécialement conçue pour protéger les mains.
Ein spezieller Griff schützt die Hände.

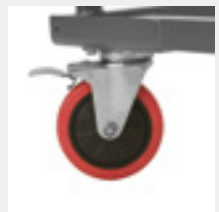

Four polyurethane wheels with built-in brake. (Two fixed wheels and two pivoting wheels).
4 ruedas de poliuretano con freno incorporado (2 ruedas fijas y 2 ruedas pivotantes).
4 roulettes en polyuréthane avec frein intégré. (2 roulettes fixes et 2 roulettes pivotantes).
4 PU-Räder mit integrierter Bremse. (2 feststehende Räder und 2 Schwelkräder).



Capacity: 28 pcs. XXL90, 18 pcs. XXL200, 15 pcs. XXL240, 24 pcs. M183.
Capacidad: 28u. XXL90, 18u. XXL200, 15u. XXL240, 24u. M183.
Capacité: 28u. XXL90, 18u. XXL200, 15u. XXL240, 24u. M183.
Fassungsvermögen: 28 Stk. XXL90, 18 Stk. XXL200, 15 Stk. XXL240, 24 Stk. M183.

thetextilecollection

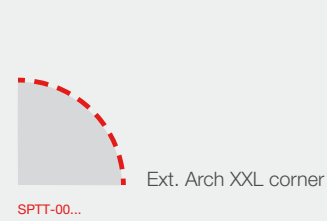

Includes self-adhesive velcro to hold the skirt in place.
Incluye velcro auto-adhesivo para sujetar el faldón.
Fourni avec ruban auto-agrippant velcro pour fixer le jupon de table.
Mit selbstklebendem Klebband zur Befestigung des Tischvorhangs.

SPTT-00... Replace (...) with the chosen colour code / Sustituir (...) por el código de color elegido / Remplacer (...) par le code de couleur choisi / (...) durch den gewählten Farbcode ersetzen

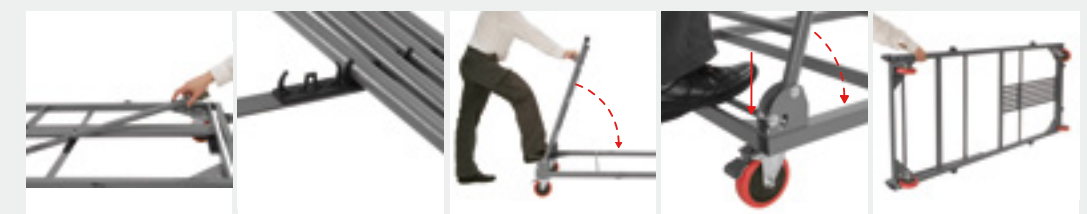

Part to hold the removable posts when folded. Bar with automatic unlocking mechanism which allows the vertical bracket to be folded. Trolley in fully folded position. Occupies a minimum of space. All parts are integrated to prevent loss.

Pieza para sujetar los postes extraíbles en posición de plegado. Barra con mecanismo automático para desbloquear y permitir el plegado del soporte vertical. Carro totalmente plegado. Ocupa mínimo espacio y todos sus componentes quedan integrados para no extraviarlos.

Pièce pour les poteaux extractibles en position de pliage. Barre avec mécanisme automatique pour blocage et déblocage et pour permettre le pliage du support vertical. Chariot entièrement plié. Occupe peu de place. Tous ses composants sont intégrés pour ne pas les perdre.

Haltevorrichtung für die herausnehmbaren Stangen in abgeklappter Position. Stange mit automatischem Mechanismus zum Entriegeln und Zusammenklappen des senkrechten Gestells. Der Wagen lässt sich vollständig zusammenklappen. Platzsparend sind alle Bestandteile integriert, damit sie nicht verloren gehen.

Code Código Code Code	EAN	Name Nombre Nom Name	Units per box Unidades por caja Unités par boîte Stückzahl pro Packung	Packaging size Medidas embalaje Dimensions emballage Verpackungsmaße	Packaging volume Volumen embalaje Volume d'emballage Verpackungsvolumen	Gross weight Peso bruto Poids brut Bruttogewicht	Loading quantity Unidades por contenedor Unités par conteneur Einheiten pro Container
PT-33	8437009886212	XXLcorner	1	93 x 94 x 6 cm 37" x 36.6" x 2.5"	0.052 m³ 1.850 ft³	9.8 kg 21.56 lb	Container 40': 1076 Container 40' HC: 1196

Code Código Code Code	EAN	Name Nombre Nom Name	Units per box Unidades por caja Unités par boîte Stückzahl pro Packung	Packaging size Medidas embalaje Dimensions emballage Verpackungsmaße	Packaging volume Volumen embalaje Volume d'emballage Verpackungsvolumen	Gross weight Peso bruto Poids brut Bruttogewicht	Loading quantity Unidades por contenedor Unités par conteneur Einheiten pro Container
RA-105A	8437009886069	XXLtrolley	1	212.7 x 101.6 x 15.2 cm 83.7" x 40" x 6"	0.328 m³ 11.583 ft³	37.1 kg 81.6 lb	Container 40': 189 Container 40' HC: 210

XXLmoon

TABLE MESA TABLE TISCH

4-5
 20.7 kg / 45.6 lb
 300 kg / 661 lb
 Water-resistant
 HDPE Light Grey POWDER-COATED STEEL Grey

Limited 10-year warranty

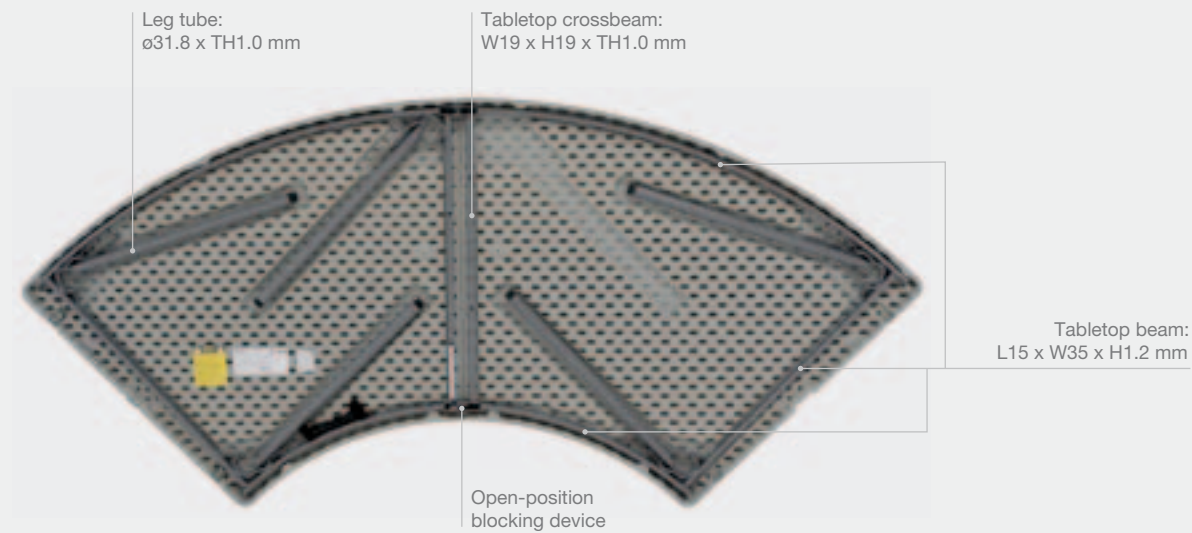
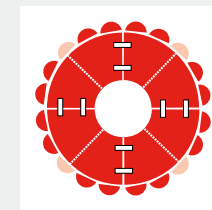
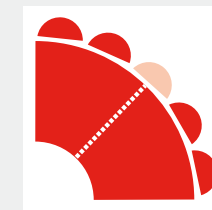

Table with circular joining system. It multiplies the range of possible configurations with "XXL" tables and the Planet180 table.
 Mesa con sistema de unión circular. Multiplica la variedad de composiciones posibles con mesas rectangulares "XXL" y con la mesa Planet180.
 Table avec système de raccord circulaire. Plusieurs compositions sont possibles, avec les tables rectangulaires « XXL » et la table Planet180.
 Tisch mit Kreisverbindungssystem. Erhöht die Kombinationsmöglichkeiten mit rechteckigen XXL-Tischen und dem Tisch Planet180.



Circular joining of four XXLmoon tables with 1 planet180 table. Capacity for 16 to 20 persons.
 Unión circular de 4 mesas XXLmoon con 1 mesa planet180. Capacidad 16 a 20 personas.
 Raccord circulaire de 4 tables XXLmoon avec 1 table planet180. Capacité 16 à 20 personnes.
 Kreisförmige Verbindung von 4 Tischen XXLmoon mit einem Tisch planet180. Bietet Platz für 16 bis 20 Personen.



Capacity: 4 or 5 persons. Area per person: 28" or 22.5".
 Capacidad: 4 o 5 personas. Espacio por persona: 71 o 57 cm.
 Capacité: 4 ou 5 personnes. Espace par personne: 71 ou 57 cm.
 Bietet Platz für 4 oder 5 Personen. Platz pro Person: 71 oder 57 cm.

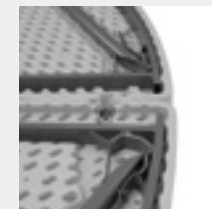

Angular or circular table joining system.
 Sistema de unión angular o circular de mesas.
 Système de raccord d'angle ou raccord circulaire de tables.
 Vorrichtung zur winkel- und kreisförmigen Verbindung von Tischen.



Automatic leg lock when in use.
 Bloqueador automático de patas en posición de uso.
 Blocage automatique des pieds en position d'usage.
 Automatische Feststellung der aufgeklappten Tischbeine.



Height adjusters on 5 legs.
 Regulador de altura en las 5 patas.
 Régulateur de hauteur sur les 5 pieds.
 Integrierte Höhenverstellung in den 5 Tischbeinen.



Folding table top. Table provided with carrying handle.
 Sobre plegable. Mesa provista de un asa.
 Surface pliable. Table munie d'une anse.
 Der zusammengeklappte Tisch hat einen Tragegriff.

thetextilecollection

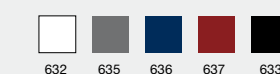
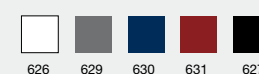
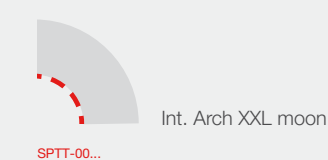
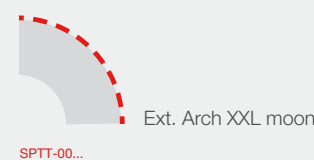

SPTT-00... Replace (...) with the chosen colour code / Sostituire (...) por el código de color elegido / Remplacer (...) par le code de couleur choisi / (...) durch den gewählten Farbcode ersetzen

Code Código Code Code	EAN	Name Nombre Nom Name	Units per box Unidades por caja Unités par boîte Stückzahl pro Packung	Packaging size Medidas embalaje Dimensions emballage Verpackungsmaße	Packaging volume Volumen embalaje Volume d'emballage Verpackungsvolumen	Gross weight Peso bruto Poids brut Bruttogewicht	Loading quantity Unidades por contenedor Unités par conteneur Einheiten pro Container
PT-35	8437009886076	XXLmoon	1	142.2 x 101 x 12 cm 56" x 39.7" x 4.7"	0.172 m ³ 6.074 ft ³	24.7 kg 54.34 lb	Container 40': 344 Container 40' HC: 390

Includes self-adhesive velcro to hold the skirt in place
 Incluye velcro auto-adhesivo para sujetar el faldón
 Fourni avec ruban auto-agrippant velcro pour fixer le juupon de table
 Mit selbstklebendem Klettband zur Befestigung des Tischvorhangs



planet120

TABLE MESA TABLE TISCH

 6
  13.7 kg
26.5 lb
  363 kg
800 lb
  Water-resistant
  HDPE
Light Gray
POWDER-COATED
STEEL
Gray

Limited
10-year
warranty

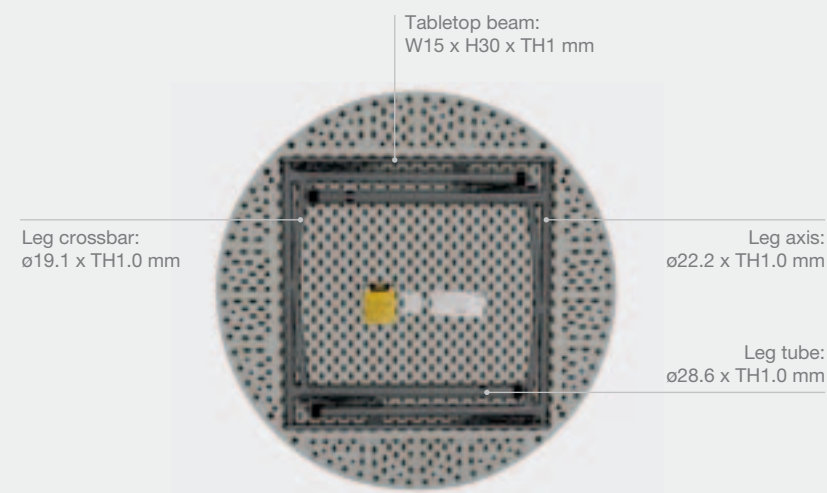

Round table for up to six diners.
Mesa redonda para hasta seis comensales.
Table ronde pour six personnes.
Runder Tisch für bis zu sechs Personen.

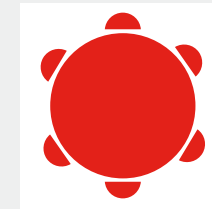

Capacity: 6 persons.
Area per person: 25".

Capacidad: 6 personas.
Espacio por persona: 64 cm.

Capacité: 6 personnes.
Espace par personne: 64 cm.

Bietet Platz für 6 Personen.
Platz pro Person: 64 cm.

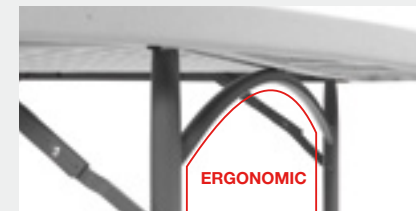

Ergonomic crosspieces for greater comfort.
Travesaños ergonómicos para un mayor confort.
Traverses ergonomiques pour plus de confort.
Ergonomische Quertraverse für mehr Bequemlichkeit.

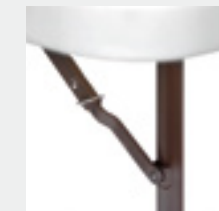

Manual lock (1) and sliding ring (2) for greater leg stability when in use.
Bloqueador manual (1) y argolla autodeslizante (2) para mayor seguridad de las patas en posición de uso.
Blocage manuel (1) et anneau autoglissant (2) pour plus de sécurité des pieds en position d'usage.
Manuelle Feststellung (1) und selbstgleitender Metallschieber (2) für eine höhere Sicherheit der Tischbeine in aufgeklappter Position.



Planet**trolley** available for 16 tables. See page 70.
Carro planet**trolley** disponible para 16 mesas. Ver pág. 70.
Chariot planet**trolley** disponible pour 16 tables. Voir page 70.
Wagen planet**trolley** lieferbar für 16 Tische. Siehe S.70.

the**textile**collection

stretch



SPTT-00...

paramount



SPTT-00...

plain



SPTT-00...

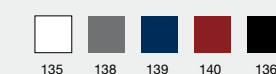
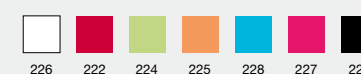

SPTT-00... Replace (...) with the chosen colour code / Sustituir (...) por el código de color elegido / Remplacer (...) par le code de couleur choisi / (...) durch den gewählten Farbcode ersetzen

Code Código Code Code	EAN	Name Nombre Nom Name	Units per box Unidades por caja Unités par boîte Stückzahl pro Packung	Packaging size Medidas embalaje Dimensions emballage Verpackungsmaße	Packaging volume Volumen embalaje Volume d'emballage Verpackungsvolumen	Gross weight Peso bruto Poids brut Bruttogewicht	Loading quantity Unidades por contenedor Unités par conteneur Einheiten pro Container
BT-48B	8437009886229	planet 120	1	124.5 x 124.5 x 6.4 cm 49" x 49" x 2.5"	0.099 m ³ 3.496 ft ³	14.4 kg 31.68 lb	Container 40': 505 Container 40' HC: 700

planet150

TABLE MESA TABLE TISCH



Limited 10 year warranty



H74.3 cm
H29.2"

50.8 mm

ø152.4 cm
ø5'

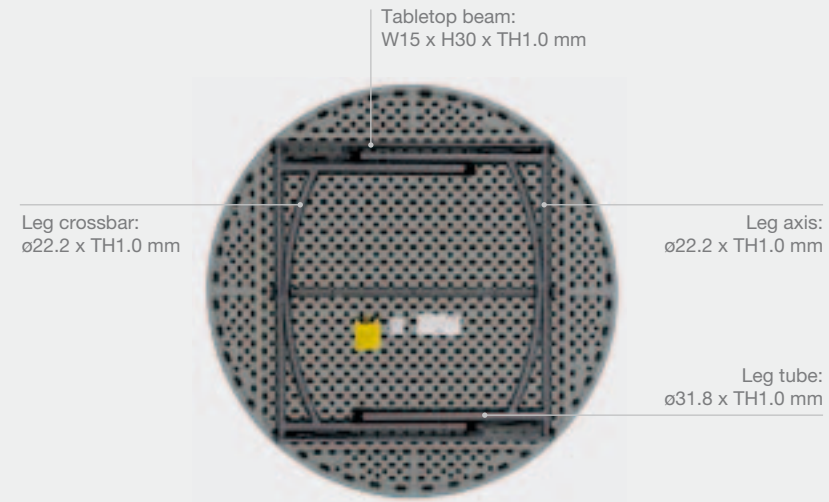

Round folding table for up to eight diners.
Mesa plegable redonda para hasta ocho comensales.
Table pliante ronde pour huit personnes.
Runder Klapp Tisch für bis zu acht Personen.

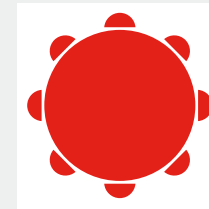

Capacity: 8 persons.
Area per person: 23.5".
Capacidad: 8 personas.
Espacio por persona: 59.7 cm.
Capacité: 8 personnes.
Espace par personne: 59.7 cm.
Bietet Platz für 8 Personen.
Platz pro Person: 59.7 cm.

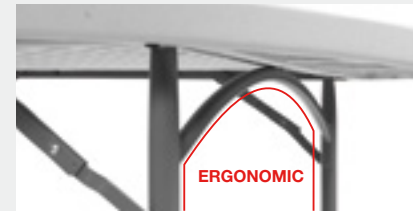

Ergonomic crosspieces for greater comfort.
Travesaños ergonómicos para un mayor confort.
Traverse ergonomiques pour plus de confort.
Ergonomische Quertraverse für mehr Bequemlichkeit.

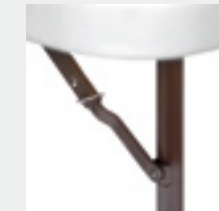

Manual lock (1) and sliding ring (2) for greater leg stability when in use.
Bloqueador manual (1) y argolla autodeslizante (2) para mayor seguridad de las patas en posición de uso.
Blocage manuel (1) et anneau autoglissant (2) pour plus de sécurité des pieds en position d'usage.
Manuelle Feststellung (1) und selbstgleitender Metallschieber (2) für eine höhere Sicherheit der Tischbeine in aufgeklappter Position.



Planetrolley available for 14 tables. See page 70.
Carro planetrolley disponible para 14 mesas. Ver pág. 70.
Chariot planetrolley disponible pour 14 tables. Voir page 70.
Wagen planetrolley lieferbar für 14 Tische. Siehe S.70.

thetextilecollection

stretch



SPTT-00...

paramount



SPTT-00...

plain



SPTT-00...



233 229 231 232 235 234 230



141 144 145 146 142



362 365 366 367 363

SPTT-00... Replace (...) with the chosen colour code / Sustituir (...) por el código de color elegido / Remplacer (...) par le code de couleur choisi / (...) durch den gewählten Farbcode ersetzen

Code Código Code Code	EAN	Name Nombre Nom Name	Units per box Unidades por caja Unités par boîte Stückzahl pro Packung	Packaging size Medidas embalaje Dimensions emballage Verpackungsmaße	Packaging volume Volumen embalaje Volume d'emballage Verpackungsvolumen	Gross weight Peso bruto Poids brut Bruttogewicht	Loading quantity Unidades por contenedor Unités par conteneur Einheiten pro Container
BT-60B	8437009886083	planet150	1	154.9 x 154.9 x 7 cm 61" x 61" x 2.8"	0.168 m ³ 5.932 ft ³	21.86 kg 48.09 lb	Container 40': 320 Container 40' HC: 360

planet160

TABLE MESA TABLE TISCH



Limited
10-year
warranty



H74.3 cm
H29.2"

50.8 mm

ø160 cm
ø63"

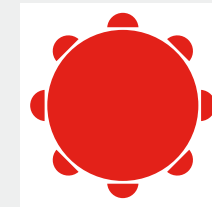
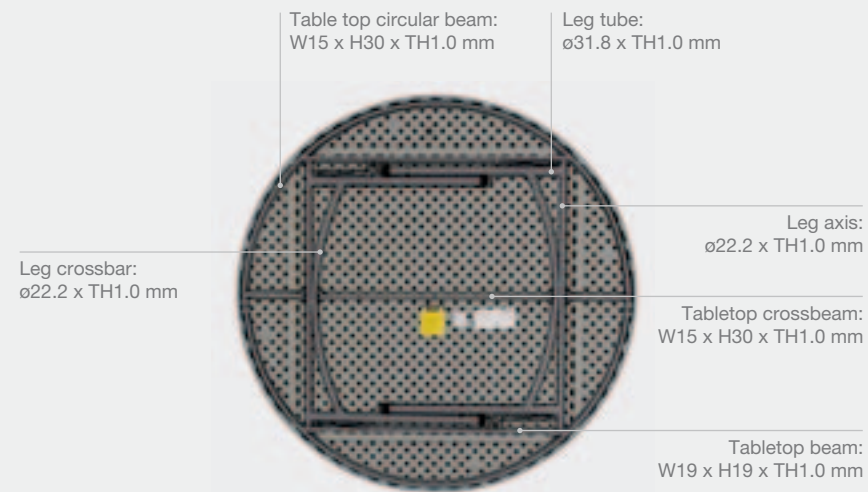

Capacity: 8 persons.
Area per person: 24.7".

Capacidad: 8 personas.
Espacio por persona: 62,8 cm.

Capacité: 8 personnes.
Espace par personne: 62.8 cm.

Bietet Platz für 8 Personen.
Platz pro Person: 62.8 cm.

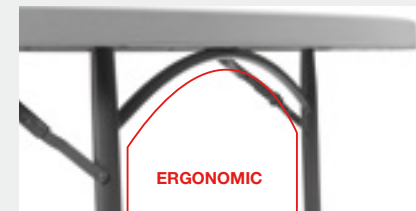

Ergonomic crosspieces for greater comfort.
Travesaños ergonómicos para un mayor confort.
Traverses ergonomiques pour plus de confort.
Ergonomische Quertraverse für mehr Bequemlichkeit.

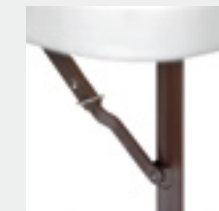

Manual lock (1) and sliding ring (2) for greater leg stability when in use.
Bloqueador manual (1) y argolla autodeslizante (2) para mayor seguridad de las patas en posición de uso.
Blocage manuel (1) et anneau autoglissant (2) pour plus de sécurité des pieds en position d'usage.
Manuelle Feststellung (1) und selbstgleitender Metallschieber (2) für eine höhere Sicherheit der Tischbeine in aufgeklappter Position.



Planet**trolley** available for 14 tables. See page 70.
Carro planet**trolley** disponible para 14 mesas. Ver pág. 70.
Chariot planet**trolley** disponible pour 14 tables. Voir page 70.
Wagen planet**trolley** lieferbar für 14 Tische. Siehe S.70.

thetextilecollection

stretch



SPTT-00...

paramount



SPTT-00...

plain



SPTT-00...

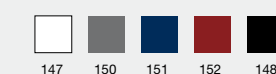
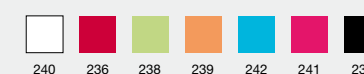

SPTT-00... Replace (...) with the chosen colour code / Sustituir (...) por el código de color elegido / Remplacer (...) par le code de couleur choisi / (...) durch den gewählten Farbcode ersetzen

Code Código Code Code	EAN	Name Nombre Nom Name	Units per box Unidades por caja Unités par boîte Stückzahl pro Packung	Packaging size Medidas embalaje Dimensions emballage Verpackungsmaße	Packaging volume Volumen embalaje Volume d'emballage Verpackungsvolumen	Gross weight Peso bruto Poids brut Bruttogewicht	Loading quantity Unidades por contenedor Unités par conteneur Einheiten pro Container
BT-63	8437010781728	planet160	1	163.3 x 162.6 x 7 cm 64.3" x 64" x 2.8"	0.185 m ³ 6.547 ft ³	29.14 kg 64.11 lb	Container 40: 308 Container 40' HC: 336

planet180

TABLE MESA TABLE TISCH

10
 29.3 kg / 64.6 lb
 350 kg / 772 lb
 Water-resistant
 HDPE Light Gray / POWDER-COATED STEEL Gray

Limited 10-year warranty



H74.3 cm
H29.2"

55 mm

ø180.3 cm
ø5.92'

Tabletop circular beam: W15 x H30 x TH1.0 mm
 Leg tube: ø31.8 x TH1.00 mm
 Leg axis: ø22.225 x TH1.0 mm
 Tabletop crossbeam: W20 x H20 x TH1.0 mm
 Tabletop frame ring: W13 x H26 x TH1.0 mm
 Leg cross bar: ø22.2 x TH1.0 mm

Round folding table for up to ten diners. The XLmoon or XXLmoon tables can be concentrically attached to make configurations for up to 20 diners. Mesa plegable redonda para hasta diez comensales. Se le pueden acoplar concéntricamente mesas XLmoon o XXLmoon para conseguir composiciones de hasta 20 comensales. Table pliante ronde pour dix personnes. Il est possible d'y ajouter des tables XLmoon ou XXLmoon pour créer des compositions pouvant accueillir jusqu'à 20 personnes. Runder Klappstisch für bis zu zehn Personen. Kann konzentrisch mit den Tischen XLmoon oder XXLmoon verbunden werden, um eine Anordnung für bis zu 20 Personen zu erzielen.

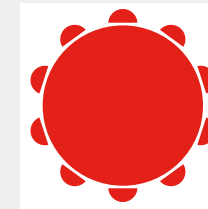

Capacity: 10 persons.
Area per person: 22.3".
Capacidad: 10 personas.
Espacio por persona: 56.6 cm.
Capacité: 10 personnes.
Espace par personne: 56.6 cm.
Bietet Platz für 10 Personen.
Platz pro Person: 56.6 cm.

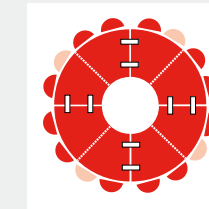

Circular joining of four XLmoon tables with 1 planet180 table. Capacity for 12 to 16 persons.
Unión circular de 4 mesas XLmoon con 1 mesa planet180. Capacidad 12 a 16 personas.
Raccord circulaire de 4 tables XLmoon avec 1 table planet180. Capacité 12 à 16 personnes.
Kreisförmige Verbindung von 4 Tischen XLmoon mit einem Tisch planet180. Bietet Platz für 12 bis 16 Personen.

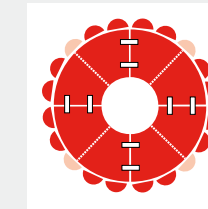

Circular joining of four XXLmoon tables with 1 planet180 table. Capacity for 16 to 20 persons.
Unión circular de 4 mesas XXLmoon con 1 mesa planet180. Capacidad 16 a 20 personas.
Raccord circulaire de 4 tables XXLmoon avec 1 table planet180. Capacité 16 à 20 personnes.
Kreisförmige Verbindung von 4 Tischen XXLmoon mit einem Tisch planet180. Bietet Platz für 16 bis 20 Personen.

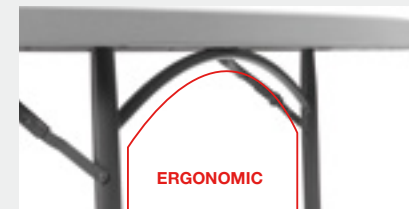

Ergonomic crosspieces for greater comfort.
Travesaños ergonómicos para un mayor confort.
Traverses ergonomiques pour plus de confort.
Ergonomische Quertraverse für mehr Bequemlichkeit.

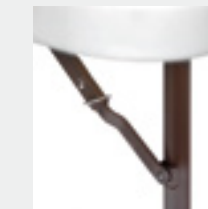

Manual lock (1) and sliding ring (2) for greater leg stability when in use.
Bloqueador manual (1) y argolla autodeslizante (2) para mayor seguridad de las patas en posición de uso.
Blocage manuel (1) et anneau autoglissant (2) pour plus de sécurité des pieds en position d'usage.
Manuelle Feststellung (1) und selbstgleitender Metallschieber (2) für eine höhere Sicherheit der Tischbeine in aufgeklappter Position.



Planetrolley available for 13 tables. See page 70.
Carro planetrolley disponible para 13 mesas. Ver pág. 70.
Chariot planetrolley disponible pour 13 tables. Voir page 70.
Wagen planetrolley lieferbar für 13 Tische. Siehe S.70.

thetextilecollection

stretch



SPTT-00...

paramount



SPTT-00...

plain



SPTT-00...

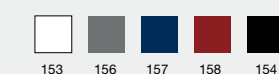
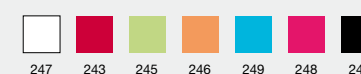

SPTT-00... Replace (...) with the chosen colour code / Sostituire (...) per el código de color elegido / Remplacer (...) par le code de couleur choisi / (...) durch den gewählten Farbcode ersetzen

Code Código Code Code	EAN	Name Nombre Nom Name	Units per box Unidades por caja Unités par boîte Stückzahl pro Packung	Packaging size Medidas embalaje Dimensions emballage Verpackungsmaße	Packaging volume Volumen embalaje Volume d'emballage Verpackungsvolumen	Gross weight Peso bruto Poids brut Bruttogewicht	Loading quantity Unidades por contenedor Unités par conteneur Einheiten pro Container
BT-71	8437009886236	planet180	1	183 x 183 x 7.3 cm 72" x 72" x 2.8"	0.243 m ³ 8.581 ft ³	33 kg 72.60 lb	Container 40': 241 Container 40' HC: 265

Trolley with extendable handle suitable for the planet**120**, planet**150**, planet**160** and planet**180** tables.
 Carro con asa extensible apto para las mesas planet**120**, planet**150**, planet**160** y planet**180**.
 Chariot avec anse extensible, compatible avec les tables planet**120**, planet**150**, planet**160** et planet**180**.
 Wagen mit ausziehbarem Griff, geeignet für die Tische planet**120**, planet**150**, planet**160** und planet**180**.

planet**trolley**

TROLLEY CARRO CHARIOT WAGEN



30.8 kg
67.9 lb



H102 cm
H40.2"

L(132 + 30) x W83.2 cm
L(52" + 11.8") x W32.7"



Extendable handle.
Asa extensible.
Anse extensible.
Ausziehbarer Griff.

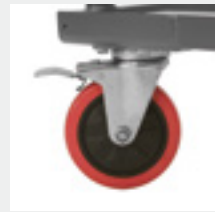

Four polyurethane wheels with built-in brake. (Two fixed wheels and two pivoting wheels).
4 ruedas de poliuretano con freno incorporado (2 ruedas fijas y 2 ruedas pivotantes).
4 roulettes en polyuréthane avec frein intégré. (2 roulettes fixes et 2 roulettes pivotantes).
4 PU-Räder mit integrierter Bremse. (2 feststehende Räder und 2 Schwenkräder).



Large loading platform.
Amplia plataforma de apoyo.
Large plateau de support.
Breite Ladefläche.



Polyester strap with tensioning mechanism to hold the tables in an upright position when the trolley is half loaded.
Correa de poliéster con tensor para mantener las mesas verticales si el carro está a media carga.
Courroie en polyester avec tendeur pour le maintien vertical des tables lorsque le chariot est à moitié plein.
Spannriemen aus Polyester zur Befestigung der senkrecht aufgestellten Tische, wenn der Wagen nur halbvoll ist.



Capacity: 16 pcs. Planet**120**, 14 pcs. Planet**150**, 14 pcs. Planet**160**, 13 pcs. Planet**180**.
Capacidad: 16u. Planet**120**, 14u. Planet**150**, 14u. Planet**160**, 13u. Planet**180**.
Capacité: 16u. Planet**120**, 14u. Planet**150**, 14u. Planet**160**, 13u. Planet**180**.
Fassungsvermögen: 16 Stk. Planet**120**, 14 Stk. Planet**150**, 14 Stk. Planet**160**, 13 Stk. Planet**180**.

Code Código Code Code	EAN	Name Nombre Nom Name	Units per box Unidades por caja Unités par boîte Stückzahl pro Packung	Packaging size Medidas embalaje Dimensions emballage Verpackungsmaße	Packaging volume Volumen embalaje Volume d'emballage Verpackungsvolumen	Gross weight Peso bruto Poids brut Bruttogewicht	Loading quantity Unidades por contenedor Unités par conteneur Einheiten pro Container
RA-106A	8437009886090	planet trolley	1	135.7 x 87.6 x 12.7 cm 53.5" x 34.5" x 5"	0.150 m ³ 5.297 ft ³	34.5 kg 75.9 lb	Container 40': 396 Container 40' HC: 460



snacktable

TABLE MESA TABLE TISCH



7.9 kg
17.6 lb



136 kg
300 lb



Water-resistant



H110 cm
H43.3"

ø70 cm
ø27.6"

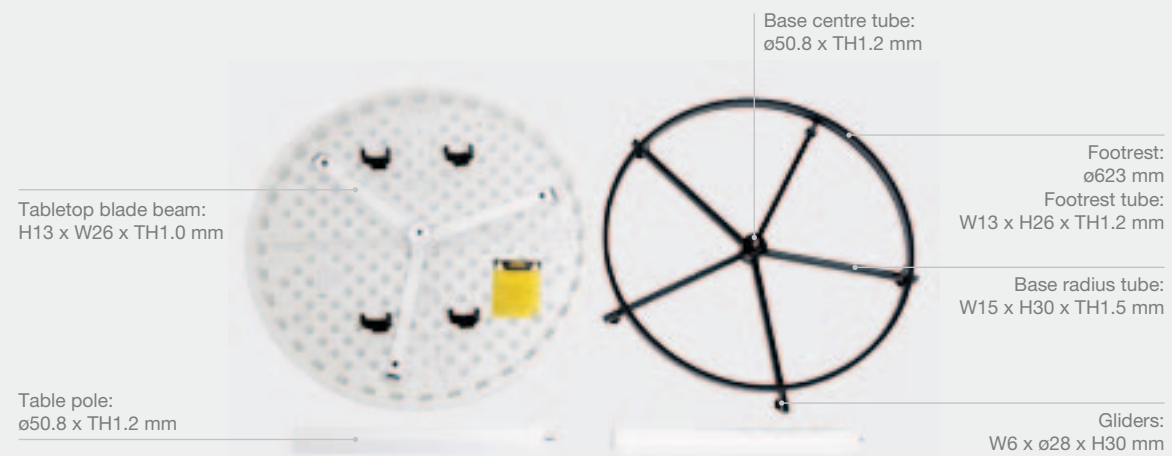

High table with footrest.
Mesa alta con reposapiés.
Table haute avec repose-pieds.
Hoher Tisch mit Fußstütze.

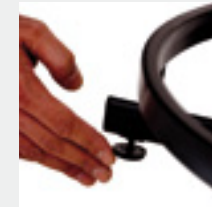

Height adjuster on the 5 legs.
Regulador de altura en las 5 patas.
Niveau réglable des 5 pieds.
Integrierte Höhenverstellung an den 5 Tischbeinen.



Table with footrest.
Mesa provista de reposapiés.
Table avec repose-pieds.
Ausgestattet mit Fußstütze.

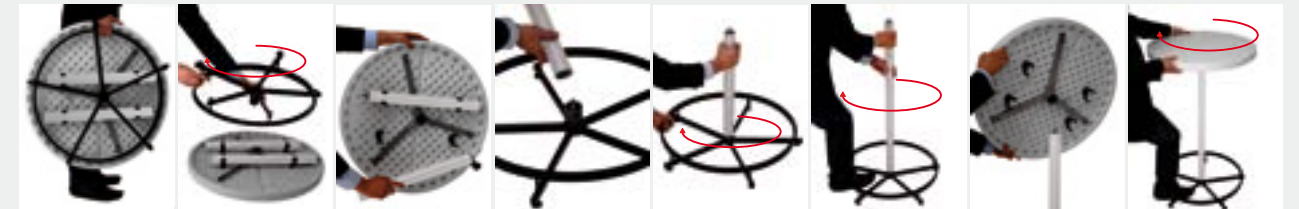

Easy to assemble by screwing the two tubes into the base and the table top for which neither screws nor tools are required. Easy to disassemble and store by unscrewing the parts, then placing the tubes in the clips located underneath the table top and finally screwing the base into the table top.

Fácil de montar enroscando entre sí la base a los dos tubos y al sobre, sin necesidad de tornillos ni herramientas. Fácil de desmontar y guardar desenroscando los componentes, posteriormente ubicando los tubos en los clips situados bajo el sobre y finalmente enroscando la base al sobre.

Montage facile en emboîtant la base aux deux tubes et au plateau, sans vis ni outils. Simple à démonter en déboîtant les éléments, et facile à ranger en fixant les tubes dans les clips situés sous le plateau, puis en vissant la base au plateau.

Leicht zusammenzubauen durch Verschrauben des Sockels mit den Stützrohren und mit der Tischplatte (ohne Schrauben und ohne Werkzeug). Einfach auseinander zu nehmen und aufzubewahren. Einzelteile auseinanderschrauben, Rohre an Halterungen unter der Tischplatte befestigen und Sockel mit Tischplatte verschrauben. Fertig.

thetextilecollection

paramount



SPTT-00...

plain



SPTT-00...

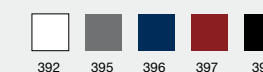

SPTT-00... Replace (...) with the chosen colour code / Sustituir (...) por el código de color elegido / Remplacer (...) par le code de couleur choisi / (...) durch den gewählten Farbcode ersetzen

Code Código Code Code	EAN	Name Nombre Nom Name	Units per box Unidades por caja Unités par boîte Stückzahl pro Packung	Packaging size Medidas embalaje Dimensions emballage Verpackungsmaße	Packaging volume Volumen embalaje Volume d'emballage Verpackungsvolumen	Gross weight Peso bruto Poids brut Bruttogewicht	Loading quantity Unidades por contenedor Unités par conteneur Einheiten pro Container
PT-43	8437010781698	snacktable	1	71.8 x 71.8 x 16.5 cm 28.3" x 28.3" x 6.5"	0.085 m ³ 3 ft ³	9.51 kg 20.92 lb	Container 40': 786 Container 40' HC: 882

cocktail80

TABLE MESA TABLE TISCH



8.9 kg
18 lb



170 kg
375 lb



Water-resistant



HDPE
Light Grey
POWDER-COATED
STEEL
Grey

Limited 10
year
warranty

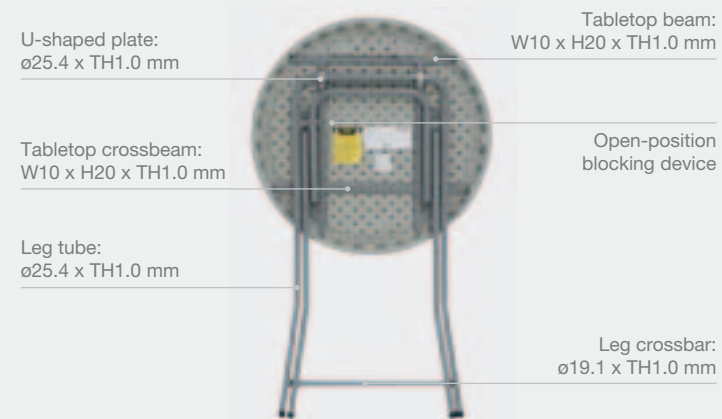

High table with automatic leg locking mechanism.
Mesa alta con bloqueador automático de las patas.
Table haute avec système de blocage automatique des pieds.
Hoher Tisch mit automatischer Beinverriegelung.



Light and easy to fold and store.
Ligera y fácil de plegar y guardar.
Légère, facile à plier et à ranger.
Leicht und einfach zusammenzuklappen und zu verstauen.

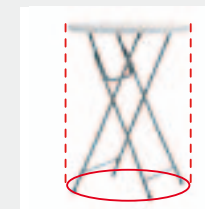

Large base which provides great stability.
Base amplia que proporciona gran estabilidad.
Base large qui confère une grande stabilité.
Eine breite Standfläche sorgt für eine ausgezeichnete Standfestigkeit.

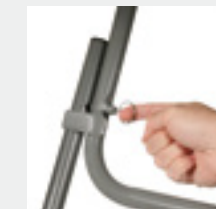

Manual lock for legs when in use.
Bloqueador de las patas en posición de uso.
Blocage des pieds en position d'utilisation.
Arretierung für Tischbeine in aufgeklappter Position.



Cocktailtrolley available for 20 tables. See page 82.
Carro Cocktailtrolley disponible para 20 mesas. Ver pág. 82.
Chariot Cocktailtrolley disponible pour 20 tables.
Voir page 82. Wagen Cocktailtrolley lieferbar für 20 Tische. Siehe S.82.

thetextilecollection

stretch



SPTT-00...

paramount



SPTT-00...

plain



SPTT-00...

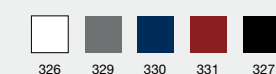
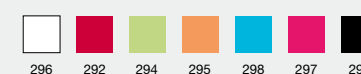

SPTT-00... Replace (...) with the chosen colour code / Sustituir (...) por el código de color elegido / Remplacer (...) par le code de couleur choisi / (...) durch den gewählten Farbcode ersetzen

Code Código Code Code	EAN	Name Nombre Nom Name	Units per box Unidades por caja Unités par boîte Stückzahl pro Packung	Packaging size Medidas embalaje Dimensions emballage Verpackungsmaße	Packaging volume Volumen embalaje Volume d'emballage Verpackungsvolumen	Gross weight Peso bruto Poids brut Bruttogewicht	Loading quantity Unidades por contenedor Unités par conteneur Einheiten pro Container
PT-36	8437009886243	cocktail80	1	141 x 82.9 x 7 cm 55.5" x 32.6" x 2.7"	0.082 m ³ 2.895 ft ³	10.85 kg 23.87 lb	Container 40: 750 Container 40' HC: 870



Folding and lightweight high stool with backrest and wide seat.
 Taburete alto plegable y ligero con respaldo y amplio asiento.
 Tabouret haut pliant et léger, avec un dossier et une assise larges.
 Hoher, leichter Klapphocker mit Rückenlehne und breitem Sitz.

markusstool

STOOL TABURETE TABOURET HOCKER



5.7 kg
12.7 lb



225 kg
500 lb



Water-resistant



HDPE
Light Grey
POWDER-COATED
STEEL
Grey



H74 cm
H29.1"

H104.4 cm
H41.1"

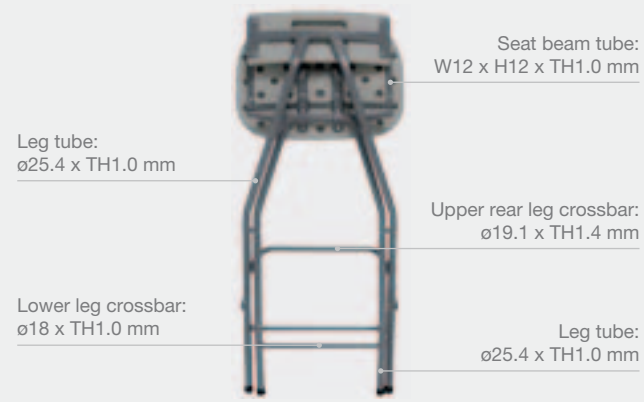

Leg tube:
ø25.4 x TH1.0 mm

Lower leg crossbar:
ø18 x TH1.0 mm

Seat beam tube:
W12 x H12 x TH1.0 mm

Upper rear leg crossbar:
ø19.1 x TH1.4 mm

Leg tube:
ø25.4 x TH1.0 mm

L49 x W48 cm
L19.3" x W18.9"



Fold-down footrest to optimise folding.

Reposapiés abatible para optimizar el plegado.

Repose-pieds rabattable pour replier le tabouret de façon optimale.

Klappbare Fußraste zum optimalen Zusammenklappen.



Spacious and comfortable seat.

Asiento amplio y confortable.

Siège large et confortable.

Breiter und bequemer Sitz.



Easy to fold, transport and store.

Fácil de plegar, transportar y guardar.

Facile à plier, à transporter et à stocker.

Einfach zusammenzuklappen, zu transportieren und aufzubewahren.

thetextilecollection

stretch



SPTT-00...

classic



SPTT-00...

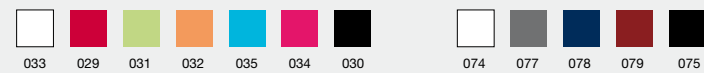

SPTT-00... Replace (...) with the chosen colour code / Sustituir (...) por el código de color elegido / Remplacer (...) par le code de couleur choisi / (...) durch den gewählten Farbcode ersetzen

Code Código Code Code	EAN	Name Nombre Nom Name	Units per box Unidades por caja Unités par boîte Stückzahl pro Packung	Packaging size Medidas embalaje Dimensions emballage Verpackungsmaße	Packaging volume Volumen embalaje Volume d'emballage Verpackungsvolumen	Gross weight Peso bruto Poids brut Bruttogewicht	Loading quantity Unidades por contenedor Unités par conteneur Einheiten pro Container
PC-24	8437010781407	markusstool	2	140 x 51 x 19.4 cm 55.13" x 20.25" x 7.63"	0.138 m ³ 4.873 ft ³	12.7 kg 28 lb	Container 40': 856 Container 40' HC: 1000



praxis80

TABLE MESA TABLE TISCH



7.6 kg
16.8 lb



170 kg
375 lb



Water-resistant



Limited
10-year
warranty



U-shaped plate:
ø25.4 x TH1.0 mm

Tabletop crossbeam:
W10 x H20 x TH1.0 mm

Leg tube:
ø25.4 x TH1.0 mm

Tabletop beam:
W10 x H20 x TH1.0 mm

Open-position blocking device:
W10 x H20 x TH1.0 mm

Leg crossbar:
ø19.1 x TH1.0 mm



Folding "bistrot" table.
Mesa "bistró" plegable.
Table bistrot pliante.
Klappbarer Bistrot-Tisch.

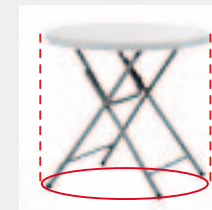

Large base which provides great stability.
Base amplia que proporciona gran estabilidad.
Base large qui confère une grande stabilité.
Eine breite Standfläche sorgt für eine ausgezeichnete Standfestigkeit.

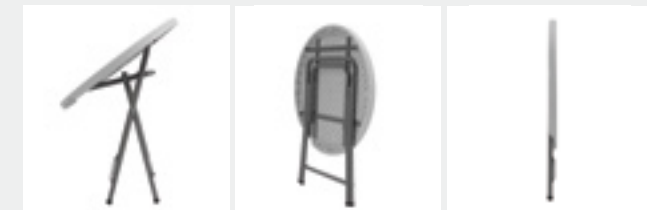

Light and easy to fold and store.
Ligera y fácil de plegar y guardar.
Légère, facile à plier et à ranger.
Leicht und einfach zusammenzuklappen und zu verstauen.



Cocktailtrolley available for 20 tables. See page 82.
Carro Cocktailtrolley disponible para 20 mesas. Ver pág. 82.
Chariot Cocktailtrolley disponible pour 20 tables.
Voir page 82. Wagen Cocktailtrolley lieferbar für 20 Tische. Siehe S.82.

the textile collection

stretch



SPTT-00...

plain



SPTT-00...

paramount



SPTT-00...

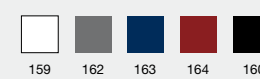
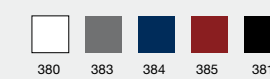
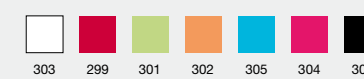

SPTT-00... Replace (...) with the chosen colour code / Sustituir (...) por el código de color elegido / Remplacer (...) par le code de couleur choisi / (...) durch den gewählten Farbcode ersetzen

Code Código Code Code	EAN	Name Nombre Nom Name	Units per box Unidades por caja Unités par boîte Stückzahl pro Packung	Packaging size Medidas embalaje Dimensions emballage Verpackungsmaße	Packaging volume Volumen embalaje Volume d'emballage Verpackungsvolumen	Gross weight Peso bruto Poids brut Bruttogewicht	Loading quantity Unidades por contenedor Unités par conteneur Einheiten pro Container
PT-37	8437009886106	praxis80	1	110.5 x 82.7 x 7 cm 43.5" x 33.6" x 2.7"	0.064 m ³ 2.260 ft ³	9 kg 20 lb	Container 40': 968 Container 40' HC: 1112

Special trolley for transporting and storing the Cocktail80 and Praxis80 tables.
 Carro especial para el transporte y almacenaje de las mesas Cocktail80 y Praxis80.
 Chariot spécial pour le transport et le stockage des tables Cocktail80 et Praxis80.
 Spezieller Transport- und Lagerwagen für die Tische Cocktail80 und Praxis80.

cocktailtrolley

TROLLEY CARRO CHARIOT WAGEN



25.5 kg
56.2 lb

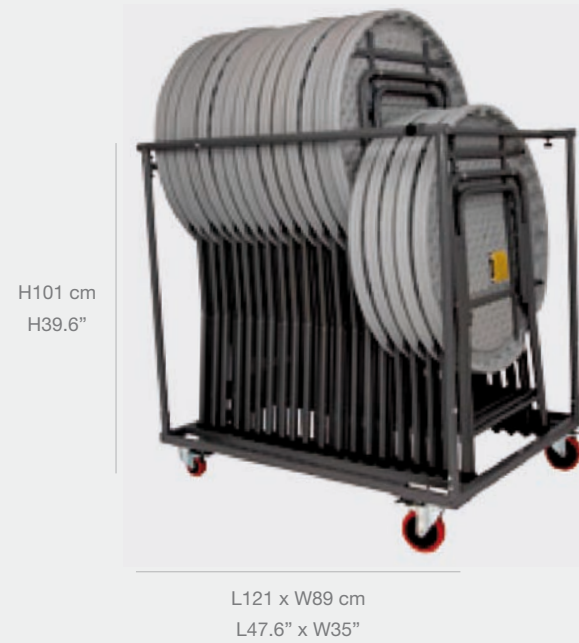

L121 x W89 cm
L47.6\" x W35\"

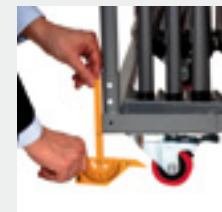

Base with 4° angle of inclination to keep the tables upright when loaded.
 Base con 4° de inclinación para mantener las mesas verticales durante la carga.
 Support d'une inclinaison de 4°, servant à tenir les tables à la verticale pendant le chargement.
 Auflage mit 4° Neigung, um die Tische beim Laden senkrecht zu halten.



Grooved base to prevent the tables from slipping.
 Base dentada para evitar que las mesas resbalen.
 Support crénelé servant à empêcher que les tables ne glissent.
 Gezackte Auflage, damit die Tische nicht verrutschen können.

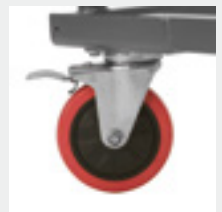

Four polyurethane wheels with built-in brake. (Two fixed wheels and two pivoting wheels).
 4 ruedas de poliuretano con freno incorporado (2 ruedas fijas y 2 ruedas pivotantes).
 4 roulettes en polyuréthane avec frein intégré. (2 roulettes fixes et 2 roulettes pivotantes).
 4 PU-Räder mit integrierter Bremse. (2 feststehende Räder und 2 Schwenkräder).



Capacity: 20 units of the cocktail80 or praxis80 tables.
 Capacidad: 20 u. mesas cocktail80 o praxis80.
 Capacité: 20 unités de tables cocktail80 ou praxis80.
 Kapazität: 20 cocktail80- oder praxis80-Tische.

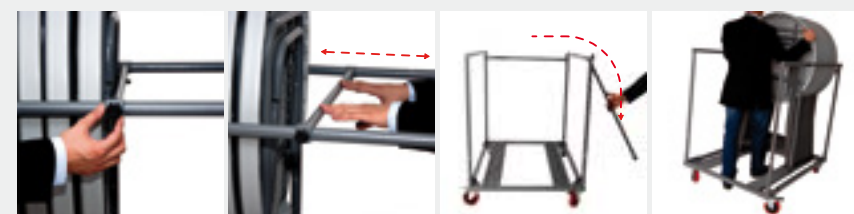

Locking bar which moves along the side rails to fix the tables in position even at half load. The bar revolves around one of the rails to allow access to the back of the trolley, making it easier to load.

Barra bloqueadora que se desliza a lo largo de las barandillas laterales para fijar las mesas incluso a media carga. La barra pivota en una de las barandillas para dejar acceso libre hasta el fondo del carro para facilitar la carga.

Barre bloquante se déplaçant le long des rampes latérales afin de fixer les tables, y compris en demie charge. La barre pivote sur une des rampes afin de laisser accès libre jusqu'au fond du chariot et faciliter ainsi le chargement.

Am Rahmen verschiebbare Sicherungsstange zur Sicherung der Tische auch bei halber Wagenladung. Die Sicherungsstange lässt sich an einer Rahmenseite schwenken. Dadurch wird der Zutritt bis zum hinteren Ende des Wagens ermöglicht und das Auf- und Abladen erleichtert.

Code Código Code Code	EAN	Name Nombre Nom Name	Units per box Unidades por caja Unités par boîte Stückzahl pro Packung	Packaging size Medidas embalaje Dimensions emballage Verpackungsmaße	Packaging volume Volumen embalaje Volume d'emballage Verpackungsvolumen	Gross weight Peso bruto Poids brut Bruttogewicht	Loading quantity Unidades por contenedor Unités par conteneur Einheiten pro Container
RA-277	8437009886809	cocktailtrolley	1	118.3 x 92.7 x 12.7 cm 46.6\" x 36.6\" x 5\"	0.140 m³ 4.944 ft³	26.9 kg 59.18 lb	Container 40': 380 Container 40' HC: 420

Multi-purpose height-adjustable personal desk.
 Mesa personal multiusos de altura regulable.
 Table individuelle multi-usages à hauteur réglable.
 Mehrzweck-Einzeltisch, höhenverstellbar.

x-uptable

TABLE MESA TABLE TISCH



4.9 kg
10.9 lb



50 kg
110 lb



Water-resistant



POWDER-COATED STEEL Grey



H34 / 46 / 56 / 61 / 66 / 71 cm
H13.4\" / 18.2\" / 22\" / 24\" / 26\" / 28\"

Leg base tube:
ø22.2 x TH1.0 mm

Leg top beam:
ø15.9 x TH1.2 mm

Leg tube:
ø19.1 x TH0.85 mm

Oval axis table:
W10 x H24.4 x TH1.0 mm



Ideal for use as an exam desk.
 Ideal para ser utilizada como mesa de examen.
 Parfaite pour servir de table d'examen.
 Ideal zur Verwendung als Prüfungstisch.



Easy to store.
 Fácil de guardar.
 Facile à stocker.
 Platzsparend in der Aufbewahrung.



Height-adjustable.
 Altura regulable.
 Hauteur réglable.
 Höhenverstellbar.



Code Código Code Code	EAN	Name Nombre Nom Name	Units per box Unidades por caja Unités par boîte Stückzahl pro Packung	Packaging size Medidas embalaje Dimensions emballage Verpackungsmaße	Packaging volume Volumen embalaje Volume d'emballage Verpackungsvolumen	Gross weight Peso bruto Poids brut Bruttogewicht	Loading quantity Unidades por contenedor Unités par conteneur Einheiten pro Container
BT-24	8437010781391	x-uptable	1	99.7 x 51.4 x 7.3 cm 39.2\" x 20.1\" x 2.9\"	0.037 m³ 1.306 ft³	5.9 kg 13 lb	Container 40': 1700 Container 40' HC: 1900

Bench with folding legs and one-piece top.
 Banco con patas plegables y sobre de una sola pieza.
 Banc avec pieds réglables et partie supérieure en une seule pièce.
 Bank mit Klappfüßen und Tischplatte aus einem Stück.

oktober**175**

BENCH BANCO BANC BANK



3



9.2 kg
20.2 lb



360 kg
800 lb



Water-resistant



HDPE
Light Grey
POWDER-COATED
STEEL
Grey

Limited
5-year
warranty

Bench with top that folds in half.
 Banco con sobre plegable por la mitad.
 Banc avec partie supérieure pliante par la moitié.
 Bank mit in der Mitte klappbarer Sitzplatte.

sharp**bench**

BENCH BANCO BANC BANK

240



4



11 kg
23.3 lb



400 kg
882 lb



Water-resistant



HDPE
Light Grey
POWDER-COATED
STEEL
Grey

Limited
5-year
warranty

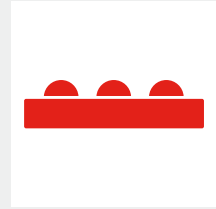

Capacity: 3 persons.
Area per person: 22.8".
Capacidad: 3 personas.
Espacio por persona: 58 cm.
Capacité: 3 personnes.
Espace par personne: 58 cm.
Kapazität: 3 Personen.
Platz pro Person: 58 cm.



One single top piece. With folding legs.
Sobre de una sola pieza. Patas plegables.
Surface d'une seule pièce. Pieds repliables.
Tischplatte aus einem Stück. Klappfüße.



Sliding ring to lock the legs in position when in use. Easy and secure.
Argolla autodeslizante para bloquear las patas en posición de uso. Fácil y seguro.
Anneau autoglisant pour blocage des pieds en position d'usage. Facile et sûr.
Selbstgleitender Metallschiebering zur Feststellung der aufgeklappten Tischbeine. Einfach und sicher.

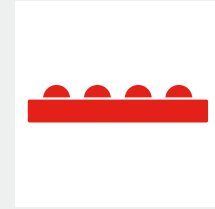

Capacity: 4 persons.
Area per person: 24".
Capacidad: 4 personas.
Espacio por persona: 61 cm.
Capacité: 4 personnes.
Espace par personne: 61 cm.
Bietet Platz für 4 Personen.
Platz pro Person: 61 cm.



Bench with folding top.
Banco con sobre plegable.
Banc avec surface pliable.
Bank mit zusammenklappbarer Sitzfläche.

thetextilecollection

stretch



SPTT-00...

plain



SPTT-00...

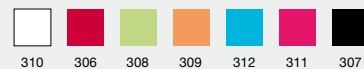

310 306 308 309 312 311 307

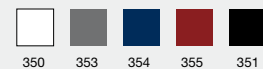

350 353 354 355 351

SPTT-00... Replace (...) with the chosen colour code / Sustituir (...) por el código de color elegido / Remplacer (...) par le code de couleur choisi / (...) durch den gewählten Farbcode ersetzen

Code Código Code Code	EAN	Name Nombre Nom Name	Units per box Unidades por caja Unités par boîte Stückzahl pro Packung	Packaging size Medidas embalaje Dimensions emballage Verpackungsmaße	Packaging volume Volumen embalaje Volume d'emballage Verpackungsvolumen	Gross weight Peso bruto Poids brut Bruttogewicht	Loading quantity Unidades por contenedor Unités par conteneur Einheiten pro Container
PC-10	8437010781131	oktober 175	1	177 x 31.4 x 8.6 cm 69.7" x 12.4" x 3.4"	0.047 m ³ 1.659 ft ³	10.5 kg 23.10 lb	Container 40': 1320 Container 40' HC: 1500

Code Código Code Code	EAN	Name Nombre Nom Name	Units per box Unidades por caja Unités par boîte Stückzahl pro Packung	Packaging size Medidas embalaje Dimensions emballage Verpackungsmaße	Packaging volume Volumen embalaje Volume d'emballage Verpackungsvolumen	Gross weight Peso bruto Poids brut Bruttogewicht	Loading quantity Unidades por contenedor Unités par conteneur Einheiten pro Container
PC-13G	8436539290568	sharp bench240	1	124.5 x 32.1 x 17.5 cm 49" x 12.6" x 6.9"	0.069 m ³ 2.457 ft ³	12.59 kg 27.70 lb	Container 40': 857 Container 40' HC: 988

Table with top that folds in half and carrying handle.
 Banco con sobre plegable por la mitad y asa para su transporte.
 Banc avec partie supérieure pliante par la moitié, et anse de transport.
 Bank mit in der Mitte klappbarer Sitzplatte und Tragegriff.

sharpbench

BENCH BANCO BANC BANK



Limited
5-year
warranty

Table with top that folds in half and carrying handle.
 Mesa con sobre plegable por la mitad y asa para su transporte.
 Table avec partie supérieure pliante par la moitié, et anse de transport.
 Tisch mit in der Mitte klappbarer Tischplatte und Tragegriff.

sharptable

TABLE MESA TABLE TISCH



Limited
10-year
warranty

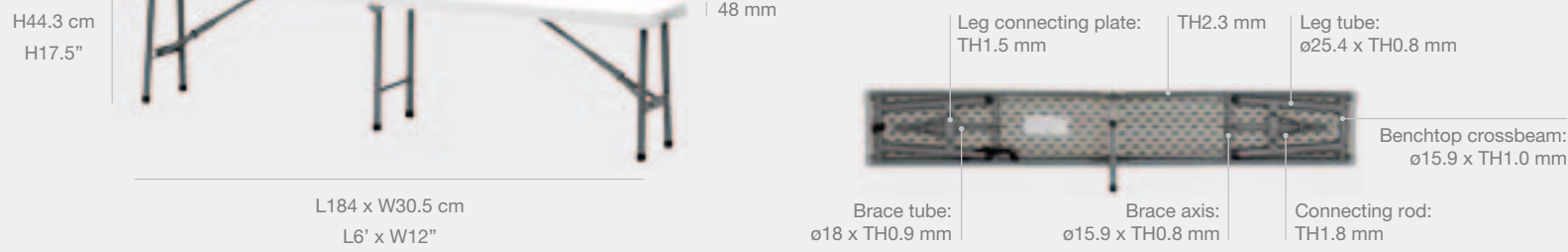

H74.3 cm
H29.2"

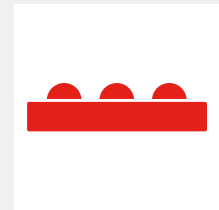

Capacity: 3 persons.
Area per person: 24".
Capacidad: 3 personas.
Espacio por persona: 61 cm.
Capacité: 3 personnes.
Espace par personne: 61 cm.
Bietet Platz für 3 Personen.
Platz pro Person: 61 cm.



Bench with folding top.
Banco con sobre plegable.
Banc avec surface pliable.
Bank mit zusammenklappbarer Sitzfläche.

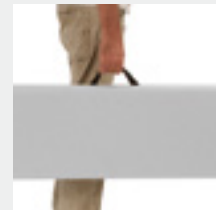

Bench provided with carrying handle for ease of transport.
Banco provisto de un asa para su fácil desplazamiento.
Banc muni d'une anse pour déplacement facile.
Die Bank ist zur Vereinfachung des Transports mit einem Tragegriff für ausgestattet.



Sliding ring to lock the legs in position when in use. Easy and secure.
Argolla autodeslizante para bloquear las patas en posición de uso. Fácil y seguro.
Anneau autoglissant pour blocage des pieds en position d'usage. Facile et sûr.
Selbstgleitender Metallschieber zur Feststellung der aufgeklappten Tischbeine. Einfach und sicher.

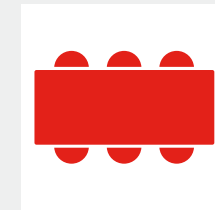

Capacity: 6 persons.
Area per person: 24".
Capacidad: 6 personas.
Espacio por persona: 61 cm.
Capacité: 6 personnes.
Espace par personne: 61 cm.
Bietet Platz für 6 Personen.
Platz pro Person: 61 cm.

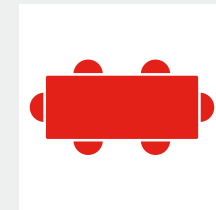

Capacity: 6 persons.
Area per person: 24".
Capacidad: 6 personas.
Espacio por persona: 61 cm.
Capacité: 6 personnes.
Espace par personne: 61 cm.
Bietet Platz für 6 Personen.
Platz pro Person: 61 cm.



Table provided with carrying handle for ease of transport.
Mesa provista de un asa para su fácil desplazamiento.
Table muni d'une anse pour déplacement facile.
Tisch hat einen Griff für den einfachen Transport.

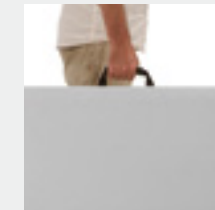

Sliding ring to lock the legs in position when in use. Easy and secure.
Argolla autodeslizante para bloquear las patas en posición de uso. Fácil y seguro.
Anneau autoglissant pour blocage des pieds en position d'usage. Facile et sûr.
Selbstgleitender Metallschieber zur Feststellung der aufgeklappten Tischbeine. Einfach und sicher.

thetextilecollection

stretch



SPTT-00...

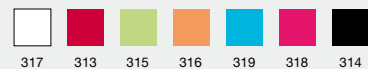

317 313 315 316 319 318 314

plain



SPTT-00...

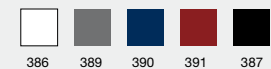

386 389 390 391 387

SPTT-00... Replace (...) with the chosen colour code / Sustituir (...) por el código de color elegido / Remplacer (...) par le code de couleur choisi / (...) durch den gewählten Farbcode ersetzen

thetextilecollection

stretch



SPTT-00...

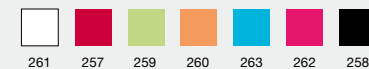

261 257 259 260 263 262 258

paramount



SPTT-00...

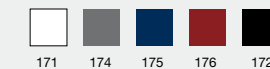

171 174 175 176 172

plain



SPTT-00...



404 407 408 409 405

SPTT-00... Replace (...) with the chosen colour code / Sustituir (...) por el código de color elegido / Remplacer (...) par le code de couleur choisi / (...) durch den gewählten Farbcode ersetzen

Code Código Code Code	EAN	Name Nombre Nom Name	Units per box Unidades por caja Unités par boîte Stückzahl pro Packung	Packaging size Medidas embalaje Dimensions emballage Verpackungsmaße	Packaging volume Volumen embalaje Volume d'emballage Verpackungsvolumen	Gross weight Peso bruto Poids brut Bruttogewicht	Loading quantity Unidades por contenedor Unités par conteneur Einheiten pro Container
PC-15F	8437009886113	sharp bench 180	1	95 x 33 x 11 cm 37.5" x 13" x 4.5"	0.031 m ³ 1.115 ft ³	8.76 kg 19.27 lb	Container 40': 1720 Container 40' HC: 1960

Code Código Code Code	EAN	Name Nombre Nom Name	Units per box Unidades por caja Unités par boîte Stückzahl pro Packung	Packaging size Medidas embalaje Dimensions emballage Verpackungsmaße	Packaging volume Volumen embalaje Volume d'emballage Verpackungsvolumen	Gross weight Peso bruto Poids brut Bruttogewicht	Loading quantity Unidades por contenedor Unités par conteneur Einheiten pro Container
BT-06FG	8437009886250	sharp table	1	77 x 95.5 x 10.5 cm 30.3" x 37.6" x 4.1"	0.077 m ³ 2.719 ft ³	15.8 kg 34.76 lb	Container 40': 810 Container 40' HC: 910

Beer table with special leg structure for soft and uneven ground.
 Mesa cervecera con estructura de patas especial para suelos blandos e irregulares.
 Table brasserie avec une structure de pieds spécialement conçue pour les sols mous et irréguliers.
 Bierbank mit speziellem Fußgestell für weiche und unregelmäßige Böden.

munich70

TABLE MESA TABLE TISCH



18.3 kg
40.3 lb



350 kg
770 lb



Water-resistant



HOPE
POWDER-COATED
STEEL
Green



Beer table with special leg structure for soft and uneven ground.
 Banco cervecero con estructura de patas especial para suelos blandos e irregulares.
 Banc brasserie avec une structure de pieds spécialement conçue pour les sols mous et irréguliers.
 Bierbank mit speziellem Fußgestell für weiche und unregelmäßige Böden.

munichbench

BENCH BANCO BANC BANK



13.3 kg
29.9 lb



400 kg
880 lb



Water-resistant



HOPE
POWDER-COATED
STEEL
Green

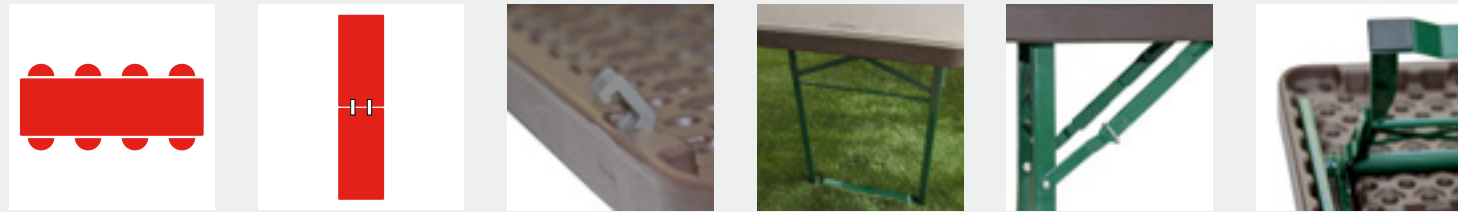

Capacity: 8 persons.
Area per person: 21.7".
Capacidad: 8 personas.
Espacio por persona: 55 cm.
Capacité: 8 personnes.
Espace par personne: 55 cm.
Bietet Platz für 8 Personen.
Platz pro Person: 55 cm.

Longitudinal table joining system.
Sistema de unión longitudinal de mesas.
Système de raccord longitudinal de tables.
Vorrichtung zur längsseitigen Verbindung der Tische.

Longitudinal table joining system.
Sistema de unión longitudinal de mesas.
Système de raccord longitudinal de tables.
Vorrichtung zur längsseitigen Verbindung der Tische.

Base frame suitable for soft ground.
Base de apoyo apta para suelos blandos.
Base d'appui apte pour des sols meublés.
Beinrahmen für weiche Böden.

Manual lock (1) and sliding ring (2) for greater leg stability when in use.
Bloqueador manual (1) y argolla autodeslizante (2) para mayor seguridad de las patas en posición de uso.
Blocage manuel (1) et anneau autoglisant (2) pour plus de sécurité des pieds en position d'usage.
Manuelle Feststellung (1) und selbstgleitender Metallschieber (2) für eine höhere Sicherheit der Tischbeine in aufgeklappter Position.

Base with anti-scratch polypropylene foot caps.
Base con tacos anti-rayas de polipropileno.
Base avec talons anti-rayures de polypropylène.
Mit integrierten Bodenschonern.

thetextilecollection

stretch



SPTT-00...



bridge



SPTT-00...



SPTT-00... Replace (...) with the chosen colour code / Sustituir (...) por el código de color elegido / Remplacer (...) par le code de couleur choisi / (...) durch den gewählten Farbcode ersetzen



Capacity: 4 persons.
Area per person: 21.7".
Capacidad: 4 personas.
Espacio por persona: 55 cm.
Capacité: 4 personnes.
Espace par personne: 55 cm.
Bietet Platz für 4 Personen.
Platz pro Person: 55 cm.

Base frame suitable for soft ground.
Base de apoyo apta para suelos blandos.
Base d'appui apte pour des sols meublés.
Beinrahmen für weiche Böden.

Manual lock (1) and sliding ring (2) for greater leg stability when in use.
Bloqueador manual (1) y argolla autodeslizante (2) para mayor seguridad de las patas en posición de uso.
Blocage manuel (1) et anneau autoglisant (2) pour plus de sécurité des pieds en position d'usage.
Manuelle Feststellung (1) und selbstgleitender Metallschieber (2) für eine höhere Sicherheit der Tischbeine in aufgeklappter Position.

Base with anti-scratch polypropylene foot caps.
Base con tacos anti-rayas de polipropileno.
Base avec talons anti-rayures de polypropylène.
Mit integrierten Bodenschonern.

thetextilecollection

stretch



SPTT-00...

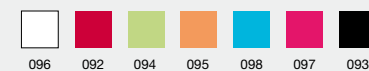

bridge



SPTT-00...

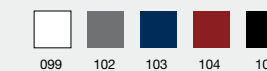

SPTT-00... Replace (...) with the chosen colour code / Sustituir (...) por el código de color elegido / Remplacer (...) par le code de couleur choisi / (...) durch den gewählten Farbcode ersetzen

Code Código Code Code	EAN	Name Nombre Nom Name	Units per box Unidades por caja Unités par boîte Stückzahl pro Packung	Packaging size Medidas embalaje Dimensions emballage Verpackungsmaße	Packaging volume Volumen embalaje Volume d'emballage Verpackungsvolumen	Gross weight Peso bruto Poids brut Bruttogewicht	Loading quantity Unidades por contenedor Unités par conteneur Einheiten pro Container
PT-46	8436539290285	munich70	1	222 x 69 x 7 cm 87.6" x 27.1" x 2.7"	0.107 m ³ 3.778 ft ³	20 kg 44 lb	Container 40': 570 Container 40' HC: 645

Code Código Code Code	EAN	Name Nombre Nom Name	Units per box Unidades por caja Unités par boîte Stückzahl pro Packung	Packaging size Medidas embalaje Dimensions emballage Verpackungsmaße	Packaging volume Volumen embalaje Volume d'emballage Verpackungsvolumen	Gross weight Peso bruto Poids brut Bruttogewicht	Loading quantity Unidades por contenedor Unités par conteneur Einheiten pro Container
PC-27	8436539290278	munichbench	1	222 x 32 x 6.9 cm 87.6" x 12.6" x 2.7"	0.049 m ³ 1.730 ft ³	15.2 kg 33.44 lb	Container 40': 1221 Container 40' HC: 1396

Stainless steel bench with optional wheels.
 Banco de trabajo de acero inoxidable con ruedas opcionales.
 Banc de travail en acier inoxydable, avec roulettes en option.
 Arbeitsbank aus Edelstahl mit optionalen Rädern.

SS60

TABLE MESA TABLE TISCH



11.6 kg
25.57 lb



Water-resistant



SS304

H89 cm
H35"



L61 x W61 cm
L24" x W24"



Height adjuster on the 4 legs.
 Regulador de altura en las 4 patas.
 Niveau réglable des 4 pieds.
 Integrierte Höhenverstellung an den 4 Tischbeinen.

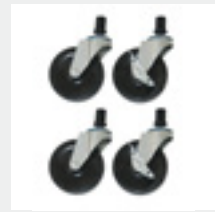

Set of four wheels available (two of which have a built-in brake). By adding the wheels, it can also serve the function of a "mobile work table" or "trolley".
 Set de cuatro ruedas disponible (dos de ellas con freno incorporado). Al incorporar las ruedas, puede cumplir también la función de "mesa de trabajo móvil" o de "carro".
 Set de quatre roues disponible (deux d'entre elles avec frein incorporé). L'incorporation des quatre roues permet d'assurer aussi la fonction de "table de travail mobile" ou de "chariot".
 Räder-Set mit vier Rädern lieferbar (zwei davon mit eingebauter Bremse). Durch den Einbau der Räder kann der Tisch auch als „fahrbare Arbeitstisch“ oder „Wagen“ eingesetzt werden.

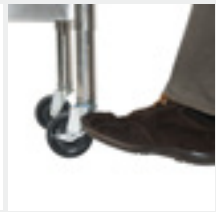

Tabletop beam plate:
SS#304, TH 0.7 mm

Shelf plate:
SS#304, TH 0.7 mm



Tabletop:
SS#304, TH 0.7 mm

Leg tube: SS#304,
size: ø42 x TH1.5 mm,
with level adjusters

Stainless steel bench with optional wheels.
 Banco de trabajo de acero inoxidable con ruedas opcionales.
 Banc de travail en acier inoxydable, avec roulettes en option.
 Arbeitsbank aus Edelstahl mit optionalen Rädern.

SS120

TABLE MESA TABLE TISCH



20.2 kg
44.53 lb



Water-resistant



SS304

H89 cm
H35"



L122 x W61 cm
L48" x W24"



Height adjuster on the 4 legs.
 Regulador de altura en las 4 patas.
 Niveau réglable des 4 pieds.
 Integrierte Höhenverstellung an den 4 Tischbeinen.

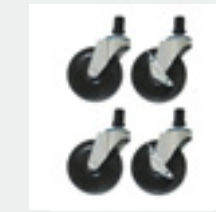

Set of four wheels available (two of which have a built-in brake). By adding the wheels, it can also serve the function of a "mobile work table" or "trolley".
 Set de cuatro ruedas disponible (dos de ellas con freno incorporado). Al incorporar las ruedas, puede cumplir también la función de "mesa de trabajo móvil" o de "carro".
 Set de quatre roues disponible (deux d'entre elles avec frein incorporé). L'incorporation des quatre roues permet d'assurer aussi la fonction de "table de travail mobile" ou de "chariot".
 Räder-Set mit vier Rädern lieferbar (zwei davon mit eingebauter Bremse). Durch den Einbau der Räder kann der Tisch auch als „fahrbare Arbeitstisch“ oder „Wagen“ eingesetzt werden.

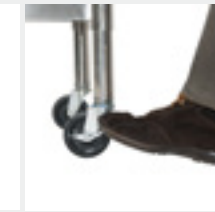

Tabletop beam plate:
SS#304, TH1.0 x W171 mm

Tabletop beam plate:
SS#304, TH1.0 x W161.5 mm

Shelf plate:
SS#304, TH1.0 x W526.2 mm

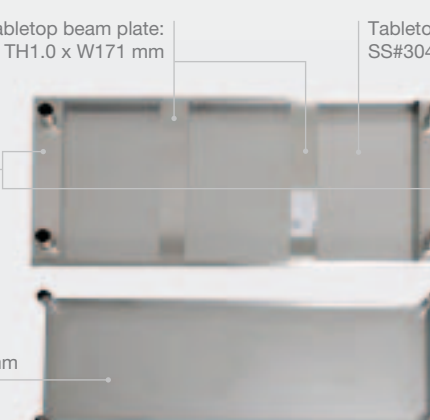

Tabletop plate:
SS#304, TH1.0 x W717 mm

Legs: SS#304,
size: ø42, TH1.5 mm,
with level adjusters

Code Código Code Code	EAN	Name Nombre Nom Name	Units per box Unidades por caja Unités par boîte Stückzahl pro Packung	Packaging size Medidas embalaje Dimensions emballage Verpackungsmaße	Packaging volume Volumen embalaje Volume d'emballage Verpackungsvolumen	Gross weight Peso bruto Poids brut Bruttogewicht	Loading quantity Unidades por contenedor Unités par conteneur Einheiten pro Container
OT002X001	8436539296485	SS60 table	Carton A Carton B	62.9 x 64.5 x 12.4 cm 24.7" x 25.4" x 4.9" 19 x 5.7 x 89 cm 7.5" x 2.3" x 35"	0.120 m ³ 4.237 ft ³	13.4 kg 29.54 lb	Container 40': 760 Container 40' HC: 876
107DG006A004A	8436539296492	SSwheels set	1	20 x 20 x 20 cm 7.9" x 7.9" x 7.9"	0.008 m ³ 0.282 ft ³		Container 40': 4300 Container 40' HC: 8700

Code Código Code Code	EAN	Name Nombre Nom Name	Units per box Unidades por caja Unités par boîte Stückzahl pro Packung	Packaging size Medidas embalaje Dimensions emballage Verpackungsmaße	Packaging volume Volumen embalaje Volume d'emballage Verpackungsvolumen	Gross weight Peso bruto Poids brut Bruttogewicht	Loading quantity Unidades por contenedor Unités par conteneur Einheiten pro Container
OT001X001	8436539296416	SS120 table	1	128.3 x 67.3 x 14 cm 50.5" x 26.5" x 5.5"	0.120 m ³ 4.237 ft ³	21.55 kg 47.5 lb	Container 40': 575 Container 40' HC: 651
107DG006A004A	8436539296492	SSwheels set	1	20 x 20 x 20 cm 7.9" x 7.9" x 7.9"	0.008 m ³ 0.282 ft ³		Container 40': 4300 Container 40' HC: 8700

Ultra-lightweight chair with high load capacity.
Silla plegable ultraligera con alta capacidad de carga.
Chaise pliante ultra-légère haute résistance.
Ultraleichter, hoch belastbarer Klappstuhl.

alexchair

CHAIR SILLA CHAISE STUHL



2.75 kg
6.1 lb



190 kg
420 lb



Water-resistant



H80.3 cm
H31.6"

L45.1 x W43.8 cm
L17.75" x W17.24"



Leg tube:
ø19.1 x TH0.85 mm

Steel plate:
TH0.8 mm

Crossbar:
ø15.9 x TH0.75 mm

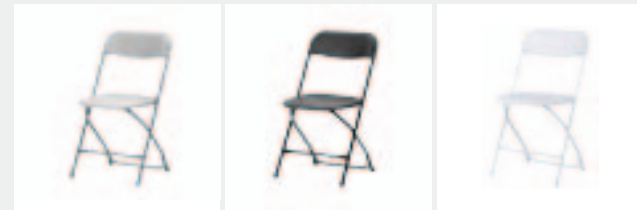

PP
Light Grey
POWDER-COATED
STEEL
Light Grey

PP
Black
POWDER-COATED
STEEL
Black

PP
White
POWDER-COATED
STEEL
White



Alextrolley available for 60 chairs. See page 98.

Alextrolley disponible para 60 sillas. Ver pág.98.

Alextrolley disponible pour 60 chaises. Voir page 98.

Wagen alextrolley lieferbar für 60 Stühle. Siehe S.98.

Ultra-lightweight chair with high load capacity and lateral joining system.
Silla plegable ultraligera con alta capacidad de carga y sistema de unión lateral.
Chaise pliante ultra-légère haute résistance avec système de raccord latéral.
Ultraleichter, hoch belastbarer Klappstuhl mit seitlichem Verbindungssystem.

alex-kchair

CHAIR SILLA CHAISE STUHL



2.75 kg
6.1 lb



190 kg
420 lb



Water-resistant



H80.3 cm
H31.6"

L46.4 x W43.8 cm
L18.26" x W17.24"

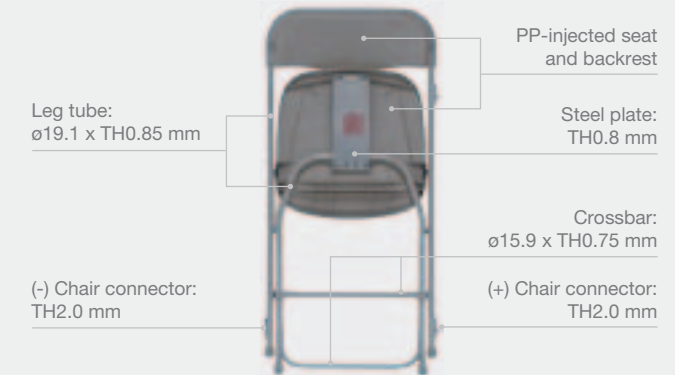

Leg tube:
ø19.1 x TH0.85 mm

(-) Chair connector:
TH2.0 mm

PP-injected seat
and backrest

Steel plate:
TH0.8 mm

Crossbar:
ø15.9 x TH0.75 mm

(+) Chair connector:
TH2.0 mm

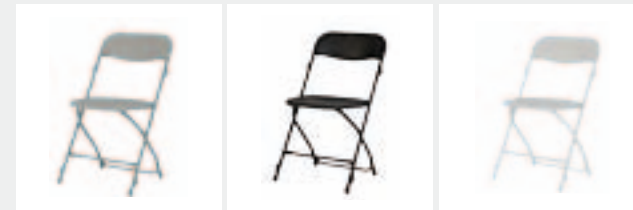

PP
Light Grey
POWDER-COATED
STEEL
Light Grey

PP
Black
POWDER-COATED
STEEL
Black

PP
White
POWDER-COATED
STEEL
White

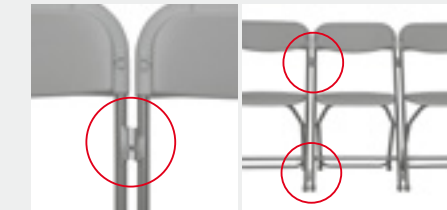

With joining system.

Con sistema de unión.

Avec système de raccord.

Mit Verbindungssystem.



Alextrolley available for 60 chairs. See page 98.

Alextrolley disponible para 60 sillas. Ver pág.98.

Alextrolley disponible pour 60 chaises. Voir page 98.

Wagen alextrolley lieferbar für 60 Stühle. Siehe S.98.

thetextilecollection

stretch



SPTT-00...

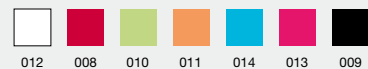

012 008 010 011 014 013 009

classic



SPTT-00...



056 059 060 061 057

sashes

classic



SPTT-00...

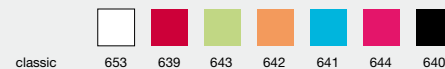

classic	653	639	643	642	641	644	640
twist	682	678	680	681	684	683	679
plain	661	657	659	660	663	662	658

twist

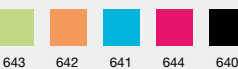

plain



thetextilecollection

stretch



SPTT-00...



012 008 010 011 014 013 009

classic



SPTT-00...



056 059 060 061 057

sashes

classic



SPTT-00...

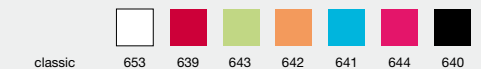

classic	653	639	643	642	641	644	640
twist	682	678	680	681	684	683	679
plain	661	657	659	660	663	662	658

twist

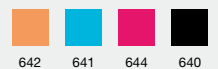

plain



SPTT-00... Replace (...) with the chosen colour code / Sustituir (...) por el código de color elegido / Remplacer (...) par le code de couleur choisi / (...) durch den gewählten Farbcode ersetzen

SPTT-00... Replace (...) with the chosen colour code / Sustituir (...) por el código de color elegido / Remplacer (...) par le code de couleur choisi / (...) durch den gewählten Farbcode ersetzen

Code Código Code Code	EAN	Name Nombre Nom Name	Units per box Unidades por caja Unités par boîte Stückzahl pro Packung	Packaging size Medidas embalaje Dimensions emballage Verpackungsmaße	Packaging volume Volumen embalaje Volume d'emballage Verpackungsvolumen	Gross weight Peso bruto Poids brut Bruttogewicht	Loading quantity Unidades por contenedor Unités par conteneur Einheiten pro Container
GC-52G	8437009886274	alexchair grey	8	45.7 x 26.3 x 99 cm	0.119 m ³	23.4 kg	Container 40': 4320
GC-52B	8437009886298	alexchair black		18" x 10.4" x 39"	4.202 ft ³	51.48 lb	Container 40' HC: 4800
GC-52W	8437009886311	alexchair white					

Code Código Code Code	EAN	Name Nombre Nom Name	Units per box Unidades por caja Unités par boîte Stückzahl pro Packung	Packaging size Medidas embalaje Dimensions emballage Verpackungsmaße	Packaging volume Volumen embalaje Volume d'emballage Verpackungsvolumen	Gross weight Peso bruto Poids brut Bruttogewicht	Loading quantity Unidades por contenedor Unités par conteneur Einheiten pro Container
GC-52K-G	8436539290209	alex-kchair grey	8	48.8 x 26.2 x 98.3 cm	0.127 m ³	23.75 kg	Container 40': 3840
GC-52K-B	8436539290629	alex-kchair black		19.2" x 10.3" x 38.7"	4.484 ft ³	52.26 lb	Container 40' HC: 4320
GC-52K-W	8436539290612	alex-kchair white					



Ultra-lightweight chair with a high backrest and high load capacity.
Silla plegable ultraligera de respaldo alto, con alta capacidad de carga.
Chaise pliante ultra-légère au dossier haut, haute résistance.
Ultraleichter, hoch belastbarer Klappstuhl mit hoher Rückenlehne.

alexandra**chair**

CHAIR SILLA CHAISE STUHL



2.8 kg
6.2 lb



190 kg
420 lb



Water-resistant

Ultra-lightweight chair with a high backrest, high load capacity and lateral joining system.
Silla plegable ultraligera de respaldo alto, con alta capacidad de carga y sistema de unión lateral.
Chaise pliante ultra-légère au dossier haut, haute résistance et avec un système de raccord latéral.
Ultraleichter, hoch belastbarer Klappstuhl mit hoher Rückenlehne und seitlichem Verbindungssystem.

alexandra-**k**chair

CHAIR SILLA CHAISE STUHL



2.8 kg
6.2 lb



190 kg
420 lb



Water-resistant



H87.5 cm
H34.44"

L45.1 x W43.2 cm
L17.7" x W17"

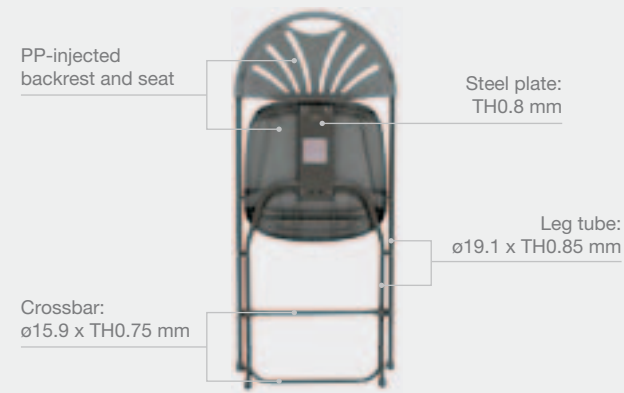

PP-injected
backrest and seat

Steel plate:
TH0.8 mm

Leg tube:
ø19.1 x TH0.85 mm

Crossbar:
ø15.9 x TH0.75 mm



H87.5 cm
H34.44"

L46.6 x W53.8 cm
L18.3" x W21.2"

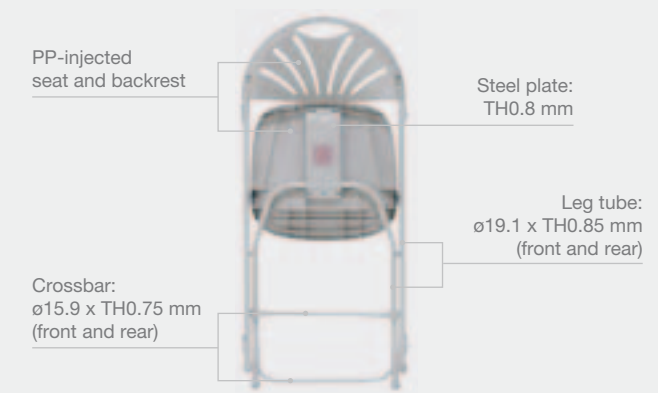

PP-injected
seat and backrest

Steel plate:
TH0.8 mm

Leg tube:
ø19.1 x TH0.85 mm
(front and rear)

Crossbar:
ø15.9 x TH0.75 mm
(front and rear)

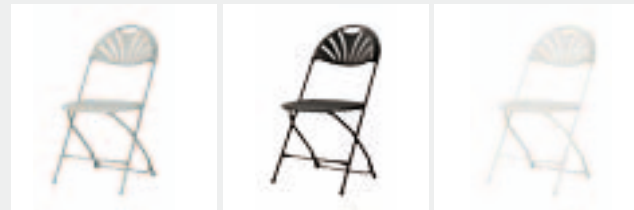

PP
Light Grey
POWDER-COATED
STEEL
Light Grey

PP
Black
POWDER-COATED
STEEL
Black

PP
White
POWDER-COATED
STEEL
White



Alexandratrolley available for 60 chairs. See page 99.

Alexandratrolley disponible para 60 sillas. Ver pág.99.

Alexandratrolley disponible pour 60 chaises. Voir page 99.

Wagen alexandratrolley lieferbar für 60 Stühle. Siehe S.99.

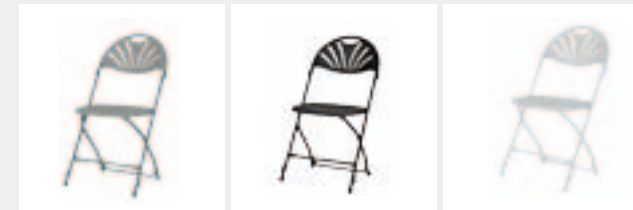

PP
Light Grey
POWDER-COATED
STEEL
Light Grey

PP
Black
POWDER-COATED
STEEL
Black

PP
White
POWDER-COATED
STEEL
White

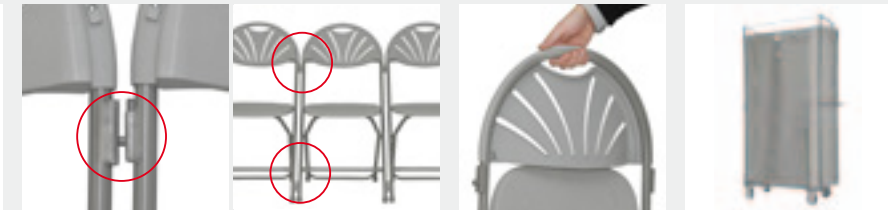

With joining system.

Con sistema de unión.

Avec système de raccord.

Mit Verbindungssystem.

Ergonomic handle.

Asidero ergonómico.

Anse ergonomique.

Ergonomischer Griff.

Alexandratrolley available for 60 chairs. See page 99.

Alexandratrolley disponible para 60 sillas. Ver pág.99.

Alexandratrolley disponible pour 60 chaises. Voir page 99.

Wagen alexandratrolley lieferbar für 60 Stühle. Siehe S.99.

thetextilecollection

stretch



SPTT-00...



005 001 003 004 007 006 002

classic



SPTT-00...

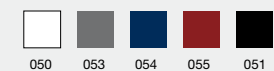

050 053 054 055 051

sashes

classic



SPTT-00...

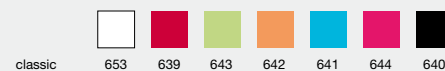

classic	653	639	643	642	641	644	640
twist	682	678	680	681	684	683	679
plain	661	657	659	660	663	662	658

twist



plain



thetextilecollection

stretch



SPTT-00...

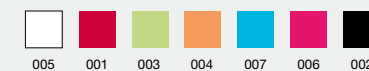

005 001 003 004 007 006 002

classic



SPTT-00...



050 053 054 055 051

sashes

classic



SPTT-00...

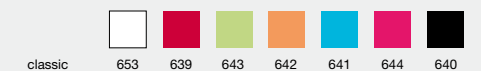

classic	653	639	643	642	641	644	640
twist	682	678	680	681	684	683	679
plain	661	657	659	660	663	662	658

twist



plain



SPTT-00... Replace (...) with the chosen colour code / Sustituir (...) por el código de color elegido / Remplacer (...) par le code de couleur choisi / (...) durch den gewählten Farbcode ersetzen

SPTT-00... Replace (...) with the chosen colour code / Sustituir (...) por el código de color elegido / Remplacer (...) par le code de couleur choisi / (...) durch den gewählten Farbcode ersetzen

Code Código Code Code	EAN	Name Nombre Nom Name	Units per box Unidades por caja Unités par boîte Stückzahl pro Packung	Packaging size Medidas embalaje Dimensions emballage Verpackungsmaße	Packaging volume Volumen embalaje Volume d'emballage Verpackungsvolumen	Gross weight Peso bruto Poids brut Bruttogewicht	Loading quantity Unidades por contenedor Unités par conteneur Einheiten pro Container
GC-50G	8437010781414	alexandra chair grey	8	45.9 x 28.4 x 107.7 cm 18.1" x 11.2" x 42.4"	0.140 m ³ 4.944 ft ³	23.7 kg 52.14 lb	Container 40': 3520 Container 40' HC: 4040
GC-50B	8437010781421	alexandra chair black					
GC-50W	8437010781438	alexandra chair white					

Code Código Code Code	EAN	Name Nombre Nom Name	Units per box Unidades por caja Unités par boîte Stückzahl pro Packung	Packaging size Medidas embalaje Dimensions emballage Verpackungsmaße	Packaging volume Volumen embalaje Volume d'emballage Verpackungsvolumen	Gross weight Peso bruto Poids brut Bruttogewicht	Loading quantity Unidades por contenedor Unités par conteneur Einheiten pro Container
GC-50K-G	8436539290599	alexandra- k chair grey	8	48.8 x 27.4 x 106 cm 19.2" x 10.8" x 41.7"	0.143 m ³ 5.049 ft ³	23.7 kg 52.14 lb	Container 40': 3200 Container 40' HC: 3600
GC-50K-B	8436539290605	alexandra- k chair black					
GC-50K-W	8436539290582	alexandra- k chair white					

Special trolley for transporting and storing the Alex and Alex-K chairs.
 Carro especial para el transporte y almacenaje de las sillas Alex y Alex-K.
 Chariot spécial pour le transport et le stockage des tables Alex et Alex-K.
 Spezieller Transport- und Lagerwagen für die Stühle Alex und Alex-K.

alextrrolley

TROLLEY CARRO CHARIOT WAGEN



19.4 kg
41.9 lb



H196.8 cm
H77.5"

L95.4 x W47.5 cm
L37.5" x W18.7"

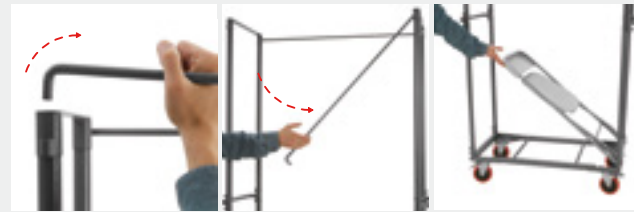

Easy locking and unlocking of the vertical posts. Ease of access for loading and unloading.
 Fácil bloqueo y desbloqueo de los postes verticales. Cómodo acceso para cargar o descargar.
 Poteaux verticaux faciles à bloquer et débloquer. Accès pratique pour chargement ou déchargement.
 Leichtes Blockieren und Entriegeln der senkrechten Stangen. Bequemer Zugriff zum Ein- oder Ausladen.

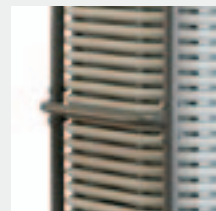

Handle specially designed to protect the hands and to occupy a minimum of space.
 Asa especialmente diseñada para proteger las manos y ocupar el mínimo espacio.
 Anse spécialement conçue pour protéger les mains et occuper un espace minime.
 Besonders geformter Griff zum Schutz der Hände und platzsparend.



Vertical posts to hold the stacked chairs in place.
 Postes verticales para inmovilizar las sillas apiladas.
 Poteaux verticaux pour immobilisation des chaises empilées.
 Senkrechte Stangen geben den gestapelten Stühlen Halt.

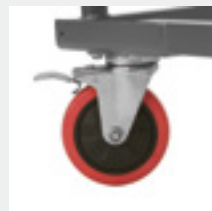

Four polyurethane wheels with built-in brake. (Two fixed wheels and two pivoting wheels).
 4 ruedas de poliuretano con freno incorporado (2 ruedas fijas y 2 ruedas pivotantes).
 4 roulettes en polyuréthane avec frein intégré. (2 roulettes fixes et 2 roulettes pivotantes).
 4 PU-Räder mit integrierter Bremse. (2 feststehende Räder und 2 Schwenkräder).



Capacity: 60 pcs. Alex or Alex-K chairs.
 Capacidad: 60u. Sillas Alex o Alex-K.
 Capacité: 60u. Chaises Alex ou Alex-K.
 Fassungsvermögen: 60 Stk. Stühle Alex oder Alex-K.

Code Código Code Code	EAN	Name Nombre Nom Name	Units per box Unidades por caja Unités par boîte Stückzahl pro Packung	Packaging size Medidas embalaje Dimensions emballage Verpackungsmaße	Packaging volume Volumen embalaje Volume d'emballage Verpackungsvolumen	Gross weight Peso bruto Poids brut Bruttogewicht	Loading quantity Unidades por contenedor Unités par conteneur Einheiten pro Container
RA-104A	8437009886137	alextrrolley	1	102.1 x 54.8 x 12 cm 40.2" x 21.6" x 4.7"	0.068 m ³ 2.401 ft ³	21.2 kg 46.6 lb	Container 40': 910 Container 40' HC: 1010

Special trolley for transporting and storing the Alexandra and Alexandra-K chairs.
 Carro especial para el transporte y almacenaje de las sillas Alexandra y Alexandra-K.
 Chariot spécial pour le transport et le stockage des chaises Alexandra et Alexandra-K.
 Spezieller Transport- und Lagerwagen für die Stühle Alexandra und Alexandra-K.

alexandratrolley

TROLLEY CARRO CHARIOT WAGEN



19.5 kg
43 lb



H196.8 cm
H77.5"

L113.5 x W47.5 cm
L44.7" x W18.7"

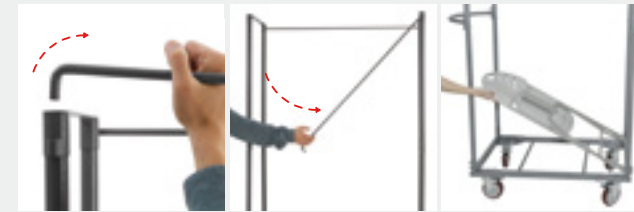

Easy locking and unlocking of the vertical posts. Ease of access for loading and unloading.
 Fácil bloqueo y desbloqueo de los postes verticales. Cómodo acceso para cargar o descargar.
 Poteaux verticaux faciles à bloquer et débloquer. Accès pratique pour chargement ou déchargement.
 Leichtes Blockieren und Entriegeln der senkrechten Stangen. Bequemer Zugriff zum Ein- oder Ausladen.



Handle specially designed to protect the hands and to occupy a minimum of space.
 Asa especialmente diseñada para proteger las manos y ocupar el mínimo espacio.
 Anse spécialement conçue pour protéger les mains et occuper un espace minime.
 Besonders geformter Griff zum Schutz der Hände und platzsparend.

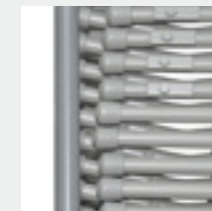

Vertical posts to hold the stacked chairs in place.
 Postes verticales para inmovilizar las sillas apiladas.
 Poteaux verticaux pour immobilisation des chaises empilées.
 Senkrechte Stangen geben den gestapelten Stühlen Halt.

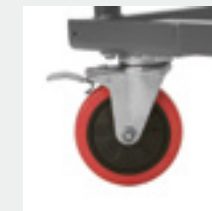

Four polyurethane wheels with built-in brake. (Two fixed wheels and two pivoting wheels).
 4 ruedas de poliuretano con freno incorporado (2 ruedas fijas y 2 ruedas pivotantes).
 4 roulettes en polyuréthane avec frein intégré. (2 roulettes fixes et 2 roulettes pivotantes).
 4 PU-Räder mit integrierter Bremse. (2 feststehende Räder und 2 Schwenkräder).



Capacity: 60 pcs. Alexandra or Alexandra-K chairs.
 Capacidad 60u. Sillas Alexandra o Alexandra-K.
 Capacité: 60u. Chaises Alexandra ou Alexandra-K.
 Fassungsvermögen: 60 Stk. Stühle Alexandra oder Alexandra-K.

Code Código Code Code	EAN	Name Nombre Nom Name	Units per box Unidades por caja Unités par boîte Stückzahl pro Packung	Packaging size Medidas embalaje Dimensions emballage Verpackungsmaße	Packaging volume Volumen embalaje Volume d'emballage Verpackungsvolumen	Gross weight Peso bruto Poids brut Bruttogewicht	Loading quantity Unidades por contenedor Unités par conteneur Einheiten pro Container
RA-104-01	8437010781858	alexandratrolley	1	100 x 55 x 12 cm 39.5" x 21.6" x 4.75"	0.066 m ³ 2.330 ft ³	21.7 kg 47.8 lb	Container 40': 910 Container 40' HC: 1010

Folding chair with a wide seat. Robust and designed for intensive use.
Silla plegable de amplio asiento. Robusta e indicada para uso intensivo.
Chaise pliante au dossier large. Robuste et indiquée pour un usage intensif.
Klappstuhl mit breitem Sitz. Robust, für intensive Nutzung geeignet.

ottochair

CHAIR SILLA CHAISE STUHL



5.15 kg
11.4 lb



225 kg
500 lb



Water-resistant

Limited
5-year
warranty

Special trolley for transporting and storing Otto chairs.
Carro especial para el transporte y almacenaje de las sillas Otto.
Chariot spécial pour le transport et le stockage des chaises Otto.
Spezieller Transport- und Lagerwagen für die Stühle Otto.

ottotrolley

TROLLEY CARRO CHARIOT WAGEN



19.7 kg
41.9 lb



Chair connector available. The distance between the two chairs with the link is 109 mm.

Conector de sillas disponible. La distancia entre las dos sillas con el link es de 109 mm.

Connecteur de chaises disponible. La distance entre les deux chaises avec le lien est de 109 mm.

Verbindungsstück für die Stühle erhältlich. Der Abstand zwischen den beiden Stühlen mit Verbindung beträgt 109 mm.

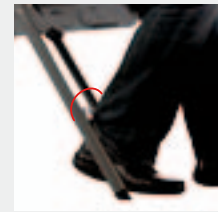

Ergonomic crosspiece.

Travesaño ergonómico.

Barre transversale ergonomique.

Ergonomisch geformte Querstrebe.

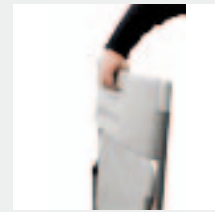

Ergonomic handle.

Asidero ergonómico.

Anse ergonomique.

Ergonomischer Griff.



Ottotrolley available for 30 chairs. See page 101.

Ottotrolley disponible para 30 sillas. Ver pág. 101.

Ottotrolley disponible pour 30 chaises. Voir page 101.

Wagen ottotrolley lieferbar für 30 Stühle. Siehe S.101.

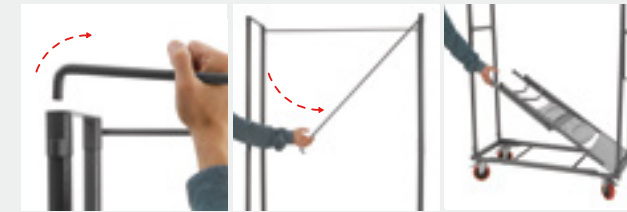

Easy locking and unlocking of the vertical posts. Ease of access for loading and unloading.

Fácil bloqueo y desbloqueo de los postes verticales. Cómodo acceso para cargar o descargar.

Poteaux verticaux faciles à bloquer et débloquer. Accès pratique pour chargement ou déchargement.

Leichtes Blockieren und Entriegeln der senkrechten Stangen. Bequemer Zugriff zum Ein- oder Ausladen.

thetextilecollection

stretch



SPTT-00...

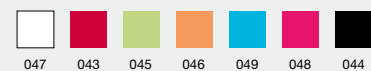

047 043 045 046 049 048 044

classic



SPTT-00...



086 089 090 091 087

sashes

classic

twist

plain



SPTT-00...

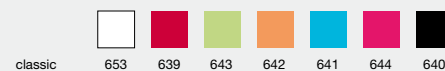

classic 653 639 643 642 641 644 640
twist 682 678 680 681 684 683 679
plain 661 657 659 660 663 662 658

SPTT-00... Replace (...) with the chosen colour code / Sustituir (...) por el código de color elegido / Remplacer (...) par le code de couleur choisi / (...) durch den gewählten Farbcode ersetzen



Vertical posts to hold the stacked chairs in place.

Postes verticales para inmovilizar las sillas apiladas.

Poteaux verticaux pour immobilisation des chaises empilées.

Senkrechte Stangen geben den gestapelten Stühlen Halt.

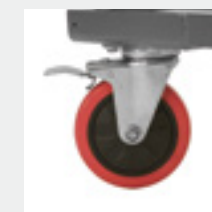

Four polyurethane wheels with built-in brake. (Two fixed wheels and two pivoting wheels).

4 ruedas de poliuretano con freno incorporado (2 ruedas fijas y 2 ruedas pivotantes).

4 roulettes en polyuréthane avec frein intégré. (2 roulettes fixes et 2 roulettes pivotantes).

4 PU-Räder mit integrierter Bremse. (2 feststehende Räder und 2 Schwenkräder).



Capacity: 30 pcs. Ottochair.

Capacidad: 30u. Ottochair.

Capacité: 30u. Ottochair.

Fassungsvermögen: 30 Stk. Ottochair.

Code Código Code Code	EAN	Name Nombre Nom Name	Units per box Unidades por caja Unités par boîte Stückzahl pro Packung	Packaging size Medidas embalaje Dimensions emballage Verpackungsmaße	Packaging volume Volumen embalaje Volume d'emballage Verpackungsvolumen	Gross weight Peso bruto Poids brut Bruttogewicht	Loading quantity Unidades por contenedor Unités par conteneur Einheiten pro Container
PC-02	8437009886267	ottochair	4	48.6 x 28.6 x 111.1 cm 19.1" x 11.2" x 43.7"	0.154 m ³ 5.438 ft ³	22.89 kg 50.36 lb	Container 40': 1544 Container 40' HC: 1740
RA-115	8437009886304	ottolink	50				

Code Código Code Code	EAN	Name Nombre Nom Name	Units per box Unidades por caja Unités par boîte Stückzahl pro Packung	Packaging size Medidas embalaje Dimensions emballage Verpackungsmaße	Packaging volume Volumen embalaje Volume d'emballage Verpackungsvolumen	Gross weight Peso bruto Poids brut Bruttogewicht	Loading quantity Unidades por contenedor Unités par conteneur Einheiten pro Container
RA-103A	8437009886120	ottotrolley	1	125.5 x 59.4 x 14 cm 49.4" x 23.4" x 5.5"	0.104 m ³ 3.672 ft ³	22 kg 48.8 lb	Container 40': 846 Container 40' HC: 940

Folding chair with wide and ergonomic seat. Robust and designed for intensive use.
Silla plegable con asiento amplio y ergonómico. Robusta e indicada para uso intensivo.
Chaise pliante au dossier large et ergonomique. Robuste et indiquée pour un usage intensif.
Klappstuhl mit breitem, ergonomisch geformtem Sitz. Robust, für intensive Nutzung geeignet.

normanchair

CHAIR SILLA CHAISE STUHL



5.1 kg
11.2 lb



225 kg
500 lb



Water-resistant

Limited
5-year
warranty

Special trolley for transporting and storing Norman chairs.
Carro especial para el transporte y almacenaje de las sillas Norman.
Chariot spécial pour le transport et le stockage des chaises Norman.
Spezieller Transport- und Lagerwagen für die Stühle Norman.

normantrolley

TROLLEY CARRO CHARIOT WAGEN



20.1 kg
43.8 lb



POWDER-COATED
STEEL
Grey



H190 cm
H74.8"



L110 x W48 cm
L43.3" x W18.9"



PP
Light Grey
POWDER-COATED
STEEL
Light Grey



PP
Black
POWDER-COATED
STEEL
Black



PP
White
POWDER-COATED
STEEL
White

Ergonomic handle.
Asidero ergonómico.
Anse ergonomique.
Ergonomischer Griff.

Ergonomic crosspiece and seat.
Travesaño y asidero ergonómicos.
Barre transversale et siège ergonomiques.
Ergonomisch Sitz und geformte Querstrebe.

Ergonomic back.
Respaldo ergonómico.
Dossier ergonomique.
Ergonomische Rückenlehne.

Chair connector available. The distance between the two chairs with the link is 109 mm.
Conector de sillas disponible. La distancia entre las dos sillas con el link es de 109 mm.
Connecteur de chaises disponible. La distance entre les deux chaises avec le lien est de 109 mm.
Verbindungsstück für die Stühle erhältlich. Der Abstand zwischen den beiden Stühlen mit Verbindung beträgt 109 mm.

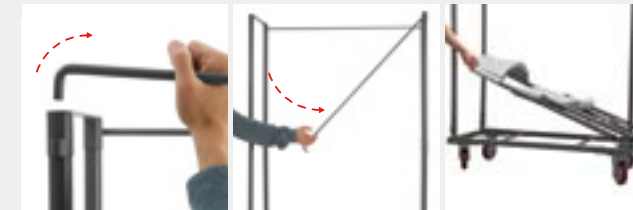

Easy locking and unlocking of the vertical posts. Ease of access for loading and unloading.
Fácil bloqueo y desbloqueo de los postes verticales. Cómodo acceso para cargar o descargar.
Poteaux verticaux faciles à bloquer et débloquer. Accès pratique pour chargement ou déchargement.
Leichtes Blockieren und Entriegeln der senkrechten Stangen. Bequemer Zugriff zum Ein- oder Ausladen.

thetextilecollection

stretch



SPTT-00...



040 036 038 039 042 041 037

classic



SPTT-00...



080 083 084 085 081

sashes



SPTT-00...

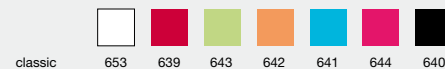

classic	653	639	643	642	641	644	640
twist	682	678	680	681	684	683	679
plain	661	657	659	660	663	662	658

SPTT-00... Replace (...) with the chosen colour code / Sustituir (...) por el código de color elegido / Remplacer (...) par le code de couleur choisi / (...) durch den gewählten Farbcode ersetzen

Code Código Code Code	EAN	Name Nombre Nom Name	Units per box Unidades por caja Unités par boîte Stückzahl pro Packung	Packaging size Medidas embalaje Dimensions emballage Verpackungsmaße	Packaging volume Volumen embalaje Volume d'emballage Verpackungsvolumen	Gross weight Peso bruto Poids brut Bruttogewicht	Loading quantity Unidades por contenedor Unités par conteneur Einheiten pro Container
PC-23-G	8437009886328	normanchairgrey	4	48.6 x 31.7 x 114.3 cm 19.1" x 12.5" x 45"	0.176 m ³ 6.215 ft ³	23.4 kg 51.48 lb	Container 40': 1336 Container 40' HC: 1536
PC-23-B	8436539296614	normanchairblack					
PC-23-W	8436539296638	normanchairwhite					
RA-115	8437009886304	ottolink					



Vertical posts to hold the stacked chairs in place.
Postes verticales para inmovilizar las sillas apiladas.
Poteaux verticaux pour immobilisation des chaises empilées.
Senkrechte Stangen geben den gestapelten Stühlen Halt.



Four polyurethane wheels with built-in brake. (Two fixed wheels and two pivoting wheels).
4 ruedas de poliuretano con freno incorporado (2 ruedas fijas y 2 ruedas pivotantes).
4 roulettes en polyuréthane avec frein intégré. (2 roulettes fixes et 2 roulettes pivotantes).
4 PU-Räder mit integrierter Bremse. (2 feststehende Räder und 2 Schwenkräder).



Capacity: 27 pcs. Normanchair.
Capacidad: 27u. Normanchair.
Capacité: 27u. Normanchair.
Fassungsvermögen: 27 Stk. Normanchair.

Code Código Code Code	EAN	Name Nombre Nom Name	Units per box Unidades por caja Unités par boîte Stückzahl pro Packung	Packaging size Medidas embalaje Dimensions emballage Verpackungsmaße	Packaging volume Volumen embalaje Volume d'emballage Verpackungsvolumen	Gross weight Peso bruto Poids brut Bruttogewicht	Loading quantity Unidades por contenedor Unités par conteneur Einheiten pro Container
RA-103-01	8437009886786	normantrolley	1	117.5 x 51.4 x 12 cm 46.2" x 20.2" x 4.7"	0.072 m ³ 2.542 ft ³	22.2 kg 48.8 lb	Container 40': 846 Container 40' HC: 940



Folding metallic chair with lateral joining system.
Silla metálica plegable con sistema de unión lateral.
Chaise métallique pliante avec système de raccord d'angle latéral.
Klappstuhl aus Metall mit seitlichem Verbindungssystem.

boston-kchair

CHAIR SILLA CHAISE STUHL



4.3 kg
9.46 lb



225 kg
500 lb

Limited
5-year
warranty



With joining system.
Con sistema de unión.
Avec système de raccord.
Mit Verbindungssystem.

thetextilecollection

stretch



SPTT-00...

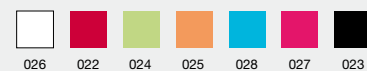

classic



SPTT-00...



sashes

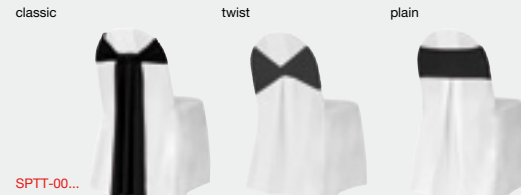

SPTT-00...

classic	653	639	643	642	641	644	640
twist	682	678	680	681	684	683	679
plain	661	657	659	660	663	662	658

SPTT-00... Replace (...) with the chosen colour code / Sustituir (...) por el código de color elegido / Remplacer (...) par le code de couleur choisi / (...) durch den gewählten Farbcode ersetzen

Code Código Code Code	EAN	Name Nombre Nom Name	Units per box Unidades por caja Unités par boîte Stückzahl pro Packung	Packaging size Medidas embalaje Dimensions emballage Verpackungsmaße	Packaging volume Volumen embalaje Volume d'emballage Verpackungsvolumen	Gross weight Peso bruto Poids brut Bruttogewicht	Loading quantity Unidades por contenedor Unités par conteneur Einheiten pro Container
SC-35K	8437009886434	boston-kchair	4	97.5 x 21.3 x 51.1 cm 38.4" x 8.4" x 20.1"	0.106 m ³ 3.743 ft ³	19.26 kg 42.37 lb	Container 40': 2304 Container 40' HC: 2640

Trolley for storing all of Zown's folding chairs and stools.
Carro para el almacenaje de todas las sillas y taburetes plegables zown.
Chariot de rangement de toutes les chaises et tabourets pliants zown.
Lagerwagen für alle Zown-Klappstühle und -hocker.

liamtrolley

TROLLEY CARRO CHARIOT WAGEN



26.23 kg
57.8 lb



POWDER-COATED
STEEL
Grey

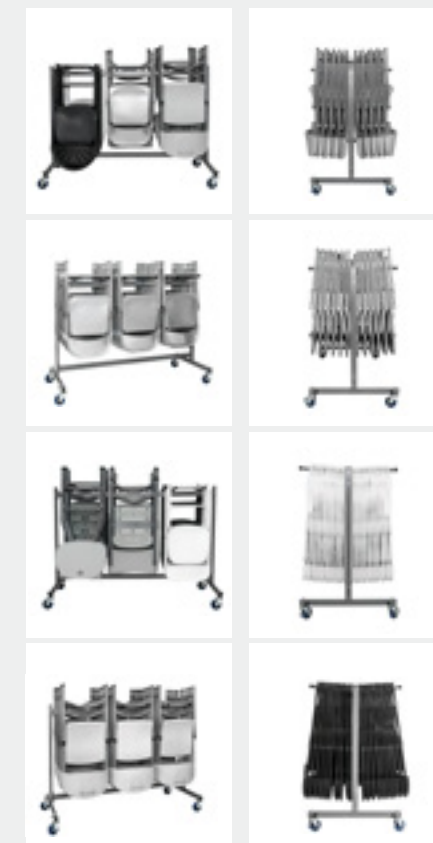

Capacity for a wide range of chairs. 60 Alexandra / 60 alex / 30 norman / 30 otto / 24 markus / 36 Boston.

Capacidad para una amplia variedad de sillas. 60 Alexandra / 60 alex / 30 norman / 30 otto / 24 markus / 36 Boston.

Capacité pour une large variété de chaises. 60 Alexandra / 60 alex / 30 norman / 30 otto / 24 markus / 36 Boston.

Aufnahmevermögen für verschiedenste Stühle. 60 Alexandra / 60 alex / 30 norman / 30 otto / 24 markus / 36 Boston.

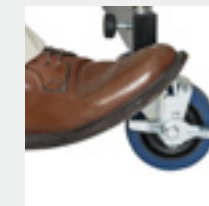

Integrated brakes in 2 of its 4 wheels.

Frenos incorporados en 2 de sus 4 ruedas.

2 des 4 roulettes sont munies d'un frein.

Mit Bremsen an 2 der 4 Rädern.



Scratch protector to prevent scratches on walls.

Anti-scratch. Protector para evitar rayar las paredes.

Anti-rayures. Protection évitant les rayures sur les murs.

Kratzschutz. Schutzvorrichtung gegen Kratzer an den Wänden.

Code Código Code Code	EAN	Name Nombre Nom Name	Units per box Unidades por caja Unités par boîte Stückzahl pro Packung	Packaging size Medidas embalaje Dimensions emballage Verpackungsmaße	Packaging volume Volumen embalaje Volume d'emballage Verpackungsvolumen	Gross weight Peso bruto Poids brut Bruttogewicht	Loading quantity Unidades por contenedor Unités par conteneur Einheiten pro Container
CB002F005	8436539296713	liamtrolley	1	176.5 x 88.3 x 15.2 cm 69.5" x 34.7" x 6"	0.236 m ³ 8.334 ft ³	31.3 kg 68.8 lb	Container 40': 252 Container 40' HC: 290

Upholstered, stackable convention chair.
Silla de convenciones tapizada apilable.
Chaise pour conférences, tapissée et empilable.
Veranstaltungsstuhl, tapeziert, stapelbar.

igorchair

CHAIR SILLA CHAISE STUHL



6.28 kg
13.84 lb



225 kg
505 lb



H83.8 cm
H33"

L44.5 x W50.2 cm
L17.5" x W19.7"

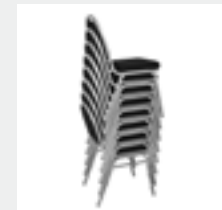

Stackable
Apilable
Empilable
Stapelbar

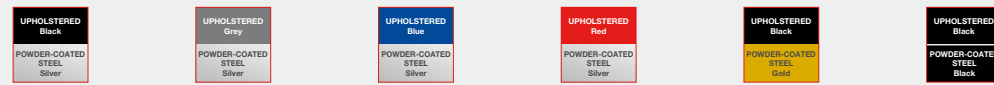
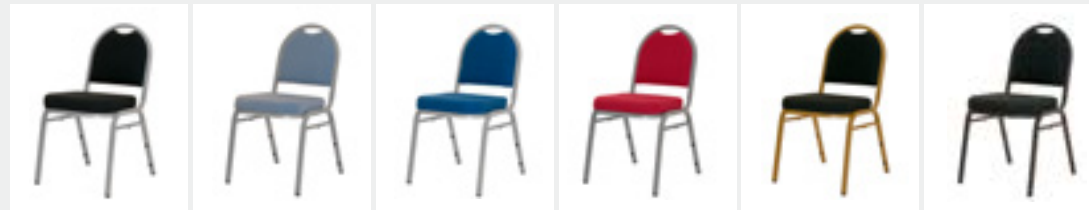

thetextilecollection

stretch



SPTT-00...



classic



SPTT-00...

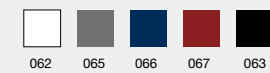

sashes



SPTT-00...

	653	639	643	642	641	644	640
classic	653	639	643	642	641	644	640
twist	682	678	680	681	684	683	679
plain	661	657	659	660	663	662	658

SPTT-00... Replace (...) with the chosen colour code / Sustituir (...) por el código de color elegido / Remplacer (...) par le code de couleur choisi / (...) durch den gewählten Farbcode ersetzen

Code Código Code Code	EAN	Name Nombre Nom Name	Units per box Unidades por caja Unités par boîte Stückzahl pro Packung	Packaging size Medidas embalaje Dimensions emballage Verpackungsmaße	Packaging volume Volumen embalaje Volume d'emballage Verpackungsvolumen	Gross weight Peso bruto Poids brut Bruttogewicht	Loading quantity Unidades por contenedor Unités par conteneur Einheiten pro Container
SKC-41-S/BK	8436539290223	igorchair silver/black	15	66 x 45.7 x 228 cm 26" x 18" x 90"	0.686 m ³ 24.225 ft ³	97 kg 213.40 lb	Container 40': 1350
SKC-41-S/R	8436539290230	igorchair silver/red					
SKC-41-S/BU	8436539290247	igorchair silver/blue					
SKC-41-S/G	8436539290216	igorchair silver/grey					
SKC-41-GD/BK	8436539290254	igorchair gold/black	17	66 x 47.6 x 260.4 cm 26" x 18.7" x 102.5"	0.818 m ³ 28.887 ft ³	109.08 kg 240.47 lb	Container 40' HC: 1530
SKC-41-BK/BK	8436539290261	igorchair black/black					

Display rack that can be taken apart for five tables.
Expositor desmontable para cinco mesas.
Présentoir démontable pour cinq tables.
Zerlegbarer Ausstellungsständer für bis zu fünf Tische.

displayrack

DISPLAY RACK EXPOSITOR SUPPORT
D'EXPOSITION AUSSTELLUNGSTÄNDER



11.2 kg
24.7 lb



H71.1 cm
H28"

L64.1 x W61 cm
L25.2" x W24"



Easy to assemble and disassemble.
Fácil de montar y desmontar.
Facile à monter et à démonter.
Einfach auf- und abzubauen.



Code Código Code Code	EAN	Name Nombre Nom Name	Units per box Unidades por caja Unités par boîte Stückzahl pro Packung	Packaging size Medidas embalaje Dimensions emballage Verpackungsmaße	Packaging volume Volumen embalaje Volume d'emballage Verpackungsvolumen	Gross weight Peso bruto Poids brut Bruttogewicht	Loading quantity Unidades por contenedor Unités par conteneur Einheiten pro Container
RA-287	8437010781308	displayrack	1	72.7 x 26 x 66.7 cm 28.6" x 10.2" x 26.2"	0.126 m ³ 4.449 ft ³	13.2 kg 29.04 lb	Container 40': 480 Container 40' HC: 574

Maxchief Europe S.L. reserves the right to modify or remove from the catalogue at any time and without prior notice any of the products described in it. For this reason, we cannot guarantee the availability of the products or that the specifications, colours, forms and other characteristics reproduced coincide at all times and in all details with the real ones. The total or partial reproduction of the content of this publication is strictly prohibited, as well as the images and texts that are the intellectual property of Maxchief Europe S.L, without previous written authorisation.

Maxchief Europe S.L. se reserva el derecho de modificar o descatalogar en cualquier momento y sin previo aviso cualquiera de los modelos descritos en este catálogo. Por ello, no garantiza la disponibilidad de los modelos ni que las especificaciones, colores, formas y demás características que se reproducen coincidan en todo momento y con todo detalle con los reales. Queda prohibida la reproducción total o parcial del contenido de esta publicación, así como de imágenes y textos propiedad intelectual de Maxchief Europe S.L, salvo previa autorización.

Maxchief Europe S.L. se réserve le droit de modifier ou de sortir du catalogue à tout moment et sans préavis n'importe lequel des produits décrits dans ce catalogue. C'est pourquoi elle ne garantit pas la disponibilité des produits. Elle ne garantit pas non plus que les spécifications, les couleurs, les formes et les autres caractéristiques reproduites coïncident à tout moment et dans le moindre détail avec les réelles. Il est interdit de reproduire totalement ou partiellement le contenu de cette publication, ainsi que les images et les textes, propriété intellectuelle de Maxchief Europe S.L, sauf autorisation préalable par écrit.

Maxchief Europe S.L. behält sich das Recht vor, jedes Produkt in diesem Katalog jederzeit und ohne vorherige Ankündigung zu ändern oder aus dem Lieferprogramm zu nehmen. Das Unternehmen gewährleistet daher nicht, dass die einzelnen Produkte verfügbar sind bzw. dass die tatsächlichen Spezifikationen, Farben, Formen und sonstigen Merkmale jederzeit genau mit den angegebenen übereinstimmen. Die vollständige oder teilweise Wiedergabe des Inhalts dieser Publikation sowie der Bilder und Texte, die geistiges Eigentum von Maxchief Europe S.L. sind, ist ohne vorherige schriftliche Genehmigung verboten.



ZOWN CLASSIC COLLECTION SUMMARY RESUMEN COLECCIÓN ZOWN CLASSIC RÉSUMÉ COLLECTION ZOWN CLASSIC ÜBERSICHT KOLLEKTION ZOWN CLASSIC

M183

TABLE MESA TABLE TISCH

183x46xh74 cm
72"x18.1"xh29.1"

Pg28

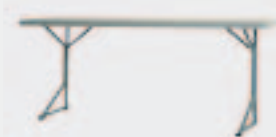

oxford180

TABLE MESA TABLE TISCH

180x50xh74.3 cm
5.9"x19.7"xh29.3"

Pg29



L120

TABLE MESA TABLE TISCH

121.9x61xh74.3 cm
4"x24"xh29.2"

Pg30

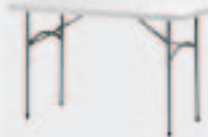

XXLtrolley

TROLLEY CARRO CHARIOT WAGEN

(202+46)x92xh115 cm
(79.6"+18.1")x36.2"xh45.3"

Pg57



XXLmoon

TABLE MESA TABLE TISCH

181.5x181.5xh74.3 cm
5.9"x5.9"xh29.2"

Pg58



XXLcorner

TABLE MESA TABLE TISCH

91.4x91.4xh74.3 cm
3'x3'h29.2"

Pg56



Ltrolley

TROLLEY CARRO CHARIOT WAGEN

131.7x62xh115 cm
51.9"x24.4"xh45.3"

Pg31



XL150

TABLE MESA TABLE TISCH

152.4x76.2xh74.3 cm
5'x30"xh29.2"

Pg34



XL180

TABLE MESA TABLE TISCH

182.9x75.2xh74.3 cm
6'x29.6"xh29.2"

Pg36



SS60

TABLE MESA TABLE TISCH

61x61xh89 cm
24"x24"xh35"

Pg90



SS120

TABLE MESA TABLE TISCH

122x61xh89 cm
48"x24"xh35"

Pg91



buffettablebase

TABLE MESA TABLE TISCH

183.3x75.2xh74 cm
72.1"x29.6"xh29.1"

Pg40

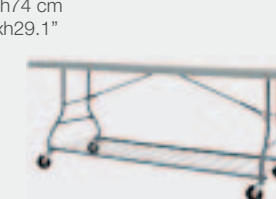

worktop180

TABLE MESA TABLE TISCH

182.9x76.2xh74.3/85.1/90.2/94.3 cm
6'x30"xh29.2"/33.5"/35.5"/37.1"

Pg38



XL240

TABLE MESA TABLE TISCH

243.8x76.2xh74.3 cm
8'x30"xh29.2"

Pg42



XLtrolley

TROLLEY CARRO CHARIOT WAGEN

(193+61)x77xh115 cm
(76"+24")x30.3"x h45.3"

Pg44



planet120

TABLE MESA TABLE TISCH

Ø122xh74.3 cm
Ø4"xh29.2"

Pg62



planet150

TABLE MESA TABLE TISCH

Ø152.4xh74.3 cm
Ø5"xh29.2"

Pg64



planet160

TABLE MESA TABLE TISCH

Ø160xh74.3 cm
Ø6.3"xh29.2"

Pg66



XLcorner

TABLE MESA TABLE TISCH

75.1x75.1xh74.3 cm
29.56"x29.56"xh29.2"

Pg48



XLmoon

TABLE MESA TABLE TISCH

166.3x166.3xh74.3 cm
5.4"x5.4"xh29.2"

Pg46



topshelf180

SHELF ESTANTE SHELF SHELF

184x30.5xh31 cm
6'x12"xh12.2"

Pg41



planet180

TABLE MESA TABLE TISCH

Ø180.3xh74.3 cm
Ø5.92"xh29.2"

Pg68



planettrolley

TROLLEY CARRO CHARIOT WAGEN

(132+30)x83.2xh102 cm
(52"+11.8")x32.7"xh40.2"

Pg70



cocktail80

TABLE MESA TABLE TISCH

Ø81.3xh110 cm
Ø32"xh43.3"

Pg74



XXL90

TABLE MESA TABLE TISCH

91.4x91.4xh74.3 cm
36"x36"xh29.2"

Pg50



XXL200

TABLE MESA TABLE TISCH

198.2x91.4xh74.3 cm
6.5"x36"xh29.2"

Pg52



XXL240

TABLE MESA TABLE TISCH

240x91.4xh74.3 cm
8'x36"xh29.2"

Pg54



praxis80

TABLE MESA TABLE TISCH

Ø81.3xh74.3 cm
Ø32"xh29.2"

Pg80



cocktailtrolley

TROLLEY CARRO CHARIOT WAGEN

121x89xh101 cm
47.6"x35"xh39.6"

Pg82



snacktable

TABLE MESA TABLE TISCH

Ø70xh110 cm
Ø27.6"xh43.3"

Pg72



sharp**table**

TABLE MESA TABLE TISCH

182.9x76.2xh74.3 cm
6'x30"xh29.2"

Pg87



sharp**bench180**

BENCH BANCO BANC BANK

184x30.5xh44.5 cm
6'x12"xh17.5"

Pg86



sharp**bench240**

BENCH BANCO BANC BANK

244.5x29.4xh44.2 cm
96.26"x11.5"xh17.4"

Pg85



alex**chair**

CHAIR SILLA CHAISE STUHL

45.1x43.8xh80.3 cm
17.75"x17.24"xh31.6"

Pg92



alex**trolley**

TROLLEY CARRO CHARIOT WAGEN

95.4x47.5xh196.8 cm
37.5"x18.7"xh77.5"

Pg98



munich**70**

TABLE MESA TABLE TISCH

220x67xh77 cm
86.6"x26.4"xh30.3"

Pg88



munich**bench**

BENCH BANCO BANC BANK

220x30xh48 cm
86.6"x11.8"xh18.9"

Pg89



x-up**table**

TABLE MESA TABLE TISCH

76.2x49.5xh34/46/56/61/66/71 cm
30"x19.5"xh13.4"/18.2"/22"/24"/26"/28"

Pg83



alexandra**chair**

CHAIR SILLA CHAISE STUHL

45.1x43.2xh87.5 cm
17.7"x17"xh34.33"

Pg96



alexandra**trolley**

TROLLEY CARRO CHARIOT WAGEN

113.5x47.5xh196.8 cm
44.7"x18.7"xh77.5"

Pg99



otto**chair**

CHAIR SILLA CHAISE STUHL

47x54xh84.8 cm
18.5"x21.26"xh33.38"

Pg100



otto**trolley**

TROLLEY CARRO CHARIOT WAGEN

110x47.7xh190 cm
43.3"x18.8"xh74.8"

Pg101



display**rack**

DISPLAY RACK EXPOSITOR SUPPORT
D'EXPOSITION AUSSTELLUNGSTÄNDER

64.1x61xh71.1 cm
25.2"x24"xh28"

Pg109



alex-k**chair**

CHAIR SILLA CHAISE STUHL

46.4x43.8xh80.3 cm
18.26"x17.24"xh31.6"

Pg93



boston-k**chair**

CHAIR SILLA CHAISE STUHL

47x51xh74 cm
20"x18.5"xh29.2"

Pg106



oktober**175**

BENCH BANCO BANC BANK

175.3x29.2xh46.4 cm
69"x11.5"xh18.3"

Pg84



norman**trolley**

TROLLEY CARRO CHARIOT WAGEN

110x48xh190 cm
43.3"x18.9"xh74.8"

Pg103



markus**stool**

STOOL TABURETE TABOURET HOCKER

49x48xh104.4 cm
19.3"x18.9"xh41.1"

Pg78



alexandra-k**chair**

CHAIR SILLA CHAISE STUHL

46.6x53.8xh87.5 cm
18.3"x21.2"xh34.33"

Pg97



liam**trolley**

TROLLEY CARRO CHARIOT WAGEN

175x79xh123.5 cm
68.9"x31.1"xh48.6"

Pg107



norman**chair**

CHAIR SILLA CHAISE STUHL

47x50.7xh85.8 cm
18.5"x19.96"xh33.78"

Pg102



igor**chair**

CHAIR SILLA CHAISE STUHL

44.5x50.2xh83.8 cm
17.5"x19.7"xh33"

Pg108



by
maxchief

Zhuhai Shichang Metals, LTD

No.2 Chuangye Middle Road
Shuanglinpian Zone
Liangang Industrial Area
Zhuhai City
Guangdong Province 519045
CHINA

Maxchief Europe S.L.

Roger de Flor, 95
08013 Barcelona SPAIN
Tel. +34 93 453 66 00
Fax +34 93 451 88 94
info@maxchief.eu
www.maxchief.eu
www.zown.com



Download the Zown App for free
Available for iOS and Android tablets



CAT-ZOWNCL-16-S



8 436539 297901 >